

## 空心销轴输送链 Hollow pin conveyor chains

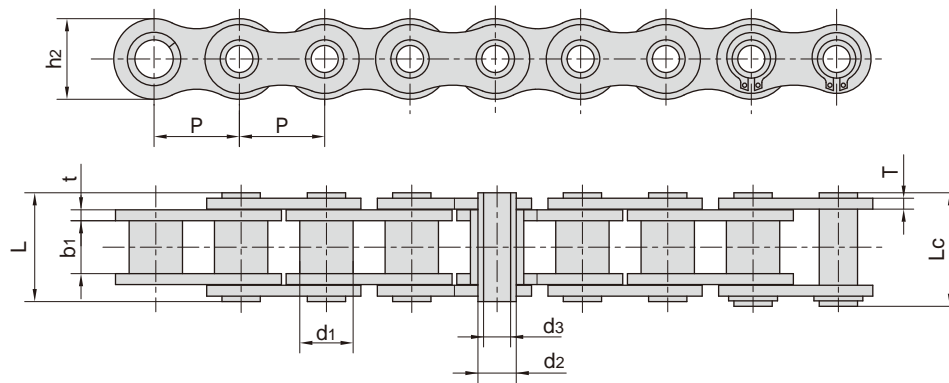

东华链号 Donghua Chain No.	节距	套筒直径	内节内宽	销轴直径		销轴长度		内链板高度	链板厚度	抗拉强度	平均抗拉强度	每米长重
	Pitch	Bush diameter	Width between inner plates	Pin diameter	Pin diameter	Pin length	Pin length	Inner plate depth	Plate thickness	Tensile strength	Average tensile strength	Weight per meter
	P	d1 max	b1 min	d2 max	d3 min	L max	Lc max	h2 max	t/T max	Q min	Q0	q
	mm	mm	mm	mm	mm	mm	mm	mm	mm	kN/lbf	kN	kg/m
08BHPF	12.700	8.51	7.75	6.55	4.50	16.4	17.6	11.80	1.60/1.30	11.1/2523	12.10	0.56
08BHPF5	12.700	8.51	7.75	6.30	4.50	16.8	18.0	12.00	1.60	9.6/2182	10.60	0.62
08BHPF9	12.700	8.51	7.75	6.30	4.50	16.5	17.6	12.10	1.50	10.5/2360	11.55	0.58
10BHPF3	15.875	10.16	9.65	7.02	5.13	19.5	20.5	14.70	1.70	10.0/2272	11.50	0.86
10BHPF4	15.875	10.16	9.50	7.20	5.00	19.8	21.3	14.00	2.03/1.60	12.5/2840	14.00	0.82
12BHPF2	19.050	12.07	11.68	8.09	6.00	22.7	23.9	16.10	1.85	14.0/3180	16.00	0.82
12BHPF3	19.050	12.07	11.70	8.22	5.75	23.6	24.9	16.20	2.42/1.85	16.0/3636	18.00	1.14
16BHPF3	25.400	15.88	17.02	11.50	8.20	35.3	37.0	23.20	4.00/3.10	49.0/11136	52.20	2.26
16BHPF4	25.400	11.70	13.50	8.00	4.30	28.9	30.2	21.30	3.00	30.0/6818	33.00	1.81
40HP	12.700	7.95	7.85	5.63	4.00	16.5	17.6	12.00	1.50	11.0/2500	12.20	0.54
08BHPF7	12.700	8.51	9.20	6.55	4.10	17.8	19.0	11.80	1.60	11.1/2523	12.10	0.64
08BHP	12.700	8.51	7.75	6.55	4.50	16.4	17.6	11.80	1.30	11.1/2523	12.10	0.52
50HP	15.875	10.16	9.40	7.03	5.13	20.7	21.9	15.09	2.03	20.0/4545	22.60	0.91
50HPF4	15.875	10.16	8.80	7.03	5.13	19.9	21.1	15.09	2.03	18.0/4180	19.20	0.89
50H-HP	15.875	10.16	9.40	7.03	5.13	22.6	23.7	15.09	2.42	20.0/4545	22.60	1.02
60HP	19.050	11.91	12.70	8.31	6.00	25.8	26.8	18.00	2.42	24.0/5455	26.90	1.29
60HPF1	19.050	11.91	12.70	8.31	5.01	25.5	26.8	18.00	2.42	28.0/6364	30.90	1.37
80HP	25.400	15.88	15.75	11.40	8.05	32.5	33.8	24.00	3.25	50.0/11364	52.00	2.26
80HPF1	25.400	11.70	13.50	7.80	4.00	27.0	28.4	21.50	2.42	27.44/6236	29.30	1.50
80HPF2	25.400	15.88	15.75	11.40	8.40	32.5	33.8	24.00	3.25	45.0/10227	48.00	2.23
80H-HP	25.400	15.88	15.75	11.40	8.05	35.7	37.0	24.00	4.00	50.0/11364	52.00	2.63
80HPF3	25.400	15.88	15.88	11.40	7.96	32.4	33.8	23.24	3.25	50.0/11364	52.00	2.26
80HPF4	25.400	11.70	13.50	7.80	4.10	29.0	30.5	21.50	3.00	40.0/9091	43.20	1.77
80HPF5	25.400	15.88	15.80	11.40	8.05	31.0	32.50	24.00	3.25/2.42	34.0/7647	37.00	2.28
HB38.1F6	38.100	18.00	15.20	14.00	10.20	34.5	36.50	27.00	3.70	45.0/10227	48.00	2.46
HB41.3	41.300	10.16	9.65	7.10	5.40	20.4	-	16.00	2.03	13.0/2924	14.30	0.67
HB41.75F5	41.750	17.11	19.90	14.11	10.30	39.0	40.4	25.26	4.00	49.0/11136	53.90	2.11
A2080HP	50.800	15.88	15.75	11.40	8.05	32.4	33.8	24.00	3.25	42.3/9615	46.10	1.60

## 空心销轴输送链 Hollow pin conveyor chains

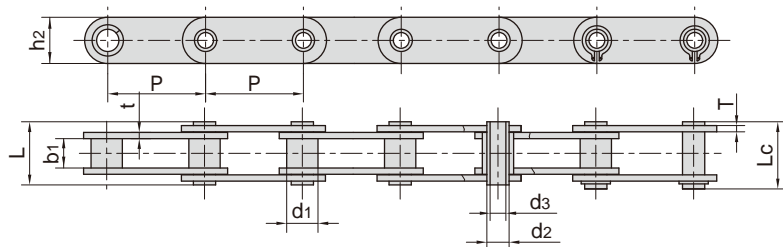

东华链号 Donghua Chain No.	节距 Pitch	套筒直径 Bush diameter	内节内宽 Width between inner plates	销轴直径 Pin diameter		销轴长度 Pin length		内链板高度 Inner plate depth	链板厚度 Plate thickness	抗拉强度 Tensile strength	平均抗拉强度 Average tensile strength	每米长重 Weight per meter
	P	d1 max	b1 min	d2 max	d3 min	L max	Lc max	h2 max	t/T max	Q min	Q0	q
	mm	mm	mm	mm	mm	mm	mm	mm	mm	kN/lbf	kN	kg/m
HP12.5	12.500	8.51	8.20	6.65	4.50	16.4	17.6	11.60	1.5/1.3	8.0/1819	8.8	0.61
C08BHP	12.700	8.51	7.75	6.55	4.50	16.4	17.6	11.80	1.6/1.3	11.0/2500	11.5	0.62
C40HP	12.700	7.95	7.85	5.63	4.00	16.5	17.6	12.00	1.50	11.0/2500	12.2	0.64
C50HP	15.875	10.16	9.40	7.03	5.13	20.7	21.9	15.09	2.03	20.0/4545	22.6	1.05
C60HP	19.050	11.91	12.70	8.31	6.00	25.8	26.8	18.00	2.42	24.0/5455	26.9	1.52
C80HP	25.400	15.88	15.75	11.40	8.05	32.5	33.8	24.00	3.25	50.0/11364	52.0	2.63
C2040HP	25.400	7.95	7.85	5.63	4.00	16.5	17.6	12.00	1.50	11.0/2500	12.6	0.46
C2040HPF1	25.400	7.95	7.85	5.63	M4	16.5	17.6	12.00	1.50	9.0/2045	9.9	0.44
C2050HP	31.750	10.16	9.40	7.22	5.12	20.5	21.8	15.00	2.03	20.4/4636	22.8	0.76
C2060HP	38.100	11.91	12.70	8.31	6.00	25.8	26.8	17.00	2.42	24.0/5455	27.1	1.02
C2060H-HP	38.100	11.91	12.70	8.31	6.00	29.2	30.2	17.00	3.25	24.0/5455	27.1	1.29
HB38.1F8	38.100	10.16	9.65	7.10	5.40	20.4	-	16.00	2.03	13.0/2954	14.3	0.67
HB38.1F15	38.100	18.00	21.00	12.00	8.10	47.8	49.0	34.00	5.60	50.0/11364	52.0	5.72
HP40F1	40.000	18.00	22.00	12.00	8.00	47.5	48.2	35.00	5.00	57.0/13049	63.8	5.38
HP40F2	40.000	18.00	22.00	12.00	8.20	47.5	48.2	35.00	5.00	57.0/13049	63.0	5.37
HP50F1	50.000	26.00	14.50	20.00	14.70	35.3	36.2	40.00	3.10	30.0/6818	33.6	3.98
HP50F7	50.000	18.00	15.00	14.00	10.20	36.0	37.5	26.00	4.00	40.0/9091	43.2	2.56
HP50F10	50.000	18.00	22.00	12.10	8.30	39.5	40.6	30.00	3.00	45.0/10227	48.0	2.73
HP50F16	50.000	18.00	17.00	14.50	10.20	39.0	40.0	27.00	4.00	40.0/9091	44.0	2.83
C2080HP	50.800	15.88	15.75	11.40	8.05	32.5	33.8	24.00	3.25	50.0/11364	52.0	1.81
HB55	55.000	18.00	22.00	14.00	10.00	43.4	44.5	30.00	4.00	50.0/11364	52.0	3.31
HB55F1	55.000	24.00	24.00	17.00	12.00	52.0	53.5	40.00	5.00	90.0/20455	100.0	6.34

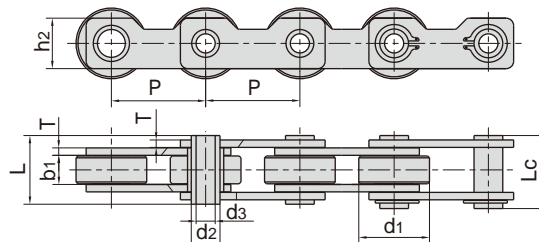

东华链号 Donghua Chain No.	节距 Pitch	滚子直径 Roller diameter	内节内宽 Width between inner plates	销轴直径 Pin diameter		销轴长度 Pin length		内链板高度 Inner plate depth	链板厚度 Plate thickness	抗拉强度 Tensile strength	平均抗拉强度 Average tensile strength	每米长重 Weight per meter
	P	d1 max	b1 min	d2 max	d3 min	L max	Lc max	h2 max	T	Q min	Q0	q
	mm	mm	mm	mm	mm	mm	mm	mm	mm	kN/lbf	kN	kg/m
HB50.8F1	50.8	38.1	15.7	15.5	10.3	35.2	36.7	27.2	4.00	55.46/51650	58.8	4.97

## 空心销轴输送链 Hollow pin conveyor chains

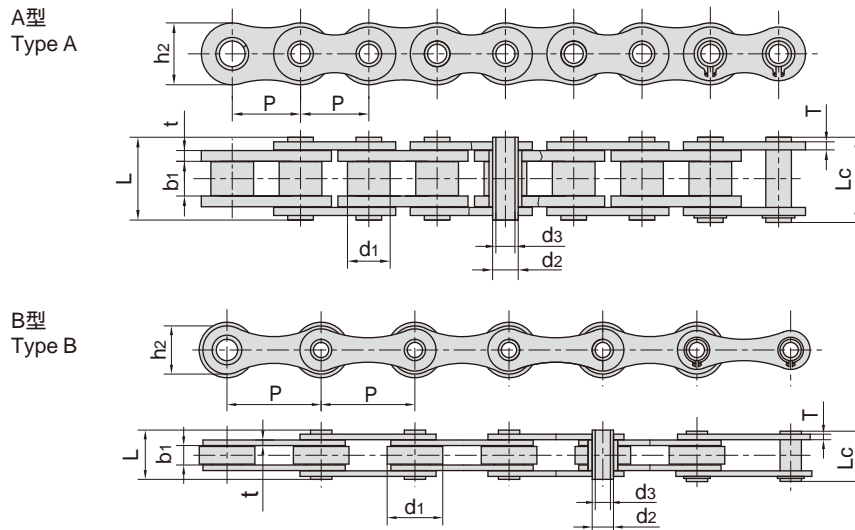

东华链号 Donghua Chain No.	节距	滚子直径	内节内宽	销轴直径		销轴长度		内链板高度	链板厚度	抗拉强度	平均抗拉强度	每米长重	型号
	Pitch	Roller diameter	Width between inner plates	Pin diameter	Pin diameter	Pin length	Pin length	Inner plate depth	Plate thickness	Tensile strength	Average tensile strength	Weight per meter	Type
	P	d1 max	b1 min	d2 max	d3 min	L max	Lc max	h2 max	t/T max	Q min	Q0	q	
	mm	mm	mm	mm	mm	mm	mm	mm	mm	kN/lbf	kN	kg/m	
10BHB	15.875	10.16	9.65	5.94	4.04	19.30	20.60	14.70	1.70	17.00/3864	20.80	0.86	A
12BHP	19.050	12.07	11.68	6.50	4.00	21.60	22.80	15.90	1.85	23.60/5364	25.90	1.09	A
60HB	19.050	11.91	12.70	7.00	5.01	25.50	26.60	18.00	2.42	20.00/4545	22.40	1.35	A
12AHBF2	19.050	11.91	12.70	7.00	5.10	26.50	27.60	18.00	2.42	20.00/4545	22.40	1.39	A
12BHPP6SLR	19.050	12.07	11.68	6.50	4.04	22.30	23.50	15.90	1.85	23.60/5364	25.96	1.12	A
12BHPP10	19.050	12.07	11.68	6.50	4.00	21.60	22.80	15.90	1.85	23.60/5364	25.90	1.08	A
HP20F1	20.000	12.00	22.00	7.00	5.00	35.70	37.70	18.00	2.42	18.00/4180	19.20	1.89	A
16BHBF1	25.400	15.88	12.70	9.53	7.05	30.80	32.20	23.00	4.15/3.10	40.00/9091	45.00	2.28	A
HB25.4	25.400	20.00	8.00	8.00	5.20	19.50	20.50	17.00	2.03	25.00/5620	28.00	1.30	A
16BHBF4	25.400	15.88	17.02	6.05	4.20	28.00	29.00	14.00	2.03	10.00/2248	11.00	1.50	A
HB25.4F7	25.400	20.00	18.00	8.00	3.00	35.00	36.00	18.00	3.00	25.00/5620	28.80	2.83	B
HB25.4F8	25.400	15.88	8.00	7.10	5.10	16.50	17.70	13.50	1.50	9.00/2024	10.00	0.78	B
HB28.58	28.580	15.88	16.20	8.03	5.50	36.30	37.00	24.00	4.00	22.00/4945	24.20	3.00	A
HP35	35.000	20.00	16.00	13.35	10.20	30.40	31.60	26.30	2.50	23.52/5345	26.40	2.02	A
HB35	35.000	20.00	16.00	14.00	10.20	32.00	33.50	38.10	3.00	40.00/9091	45.00	2.39	A
HB38.1	38.100	20.00	8.00	8.00	5.30	19.60	20.70	17.30	2.03	28.00/5682	28.80	0.98	B
HB38.1F1	38.100	20.00	18.00	10.50	5.10	39.00	40.30	22.00	4.00	60.00/13636	64.30	2.59	B
HB38.1F3	38.100	25.40	12.70	12.00	8.30	27.00	28.60	21.00	2.50	25.00/5620	28.80	1.51	B
HB38.1F4	38.100	20.00	12.70	8.00	5.20	26.00	27.20	17.00	2.42	24.00/5455	26.90	1.48	B
HP38.1F9	38.100	22.20	12.70	11.00	8.15	26.50	27.50	18.00	2.50	22.00/5000	24.40	1.46	B
HB38.1F10	38.100	25.40	25.40	14.63	10.50	54.00	54.30	33.20	6.00/4.80	50.00/11240	55.00	6.10	A
HP40F4	40.000	26.00	10.00	11.40	8.20	26.50	28.00	24.00	3.00	50.00/11240	56.70	2.20	B
*HB41.4F1	41.400	25.40	15.00	13.80	10.50	35.50	37.00	32.00	4.00	45.00/10116	49.50	3.66	B
HP41.75F1	41.750	17.10	20.20	11.11	8.20	35.70	39.00	21.65	3.10	26.50/6022	29.20	1.60	A
HP41.75F2	41.750	17.10	20.20	11.11	8.20	35.70	41.00	25.26	3.10	49.00/11136	54.80	2.04	A

\*外链板为直板形。

\*Denotes straight side outer plates.

## 空心销轴输送链 Hollow pin conveyor chains

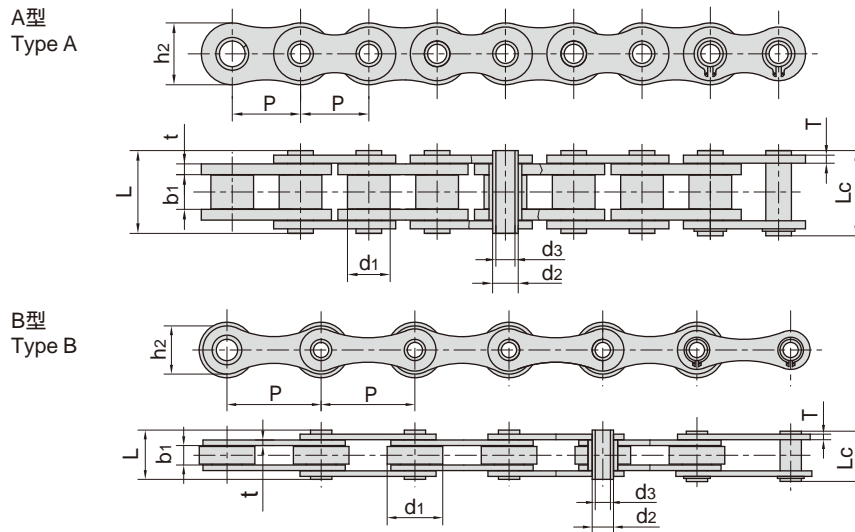

东华链号 Donghua Chain No.	节距 Pitch	滚子直径 Roller diameter	内节内宽 Width between inner plates	销轴直径 Pin diameter			销轴长度 Pin length		内链板高度 Inner plate depth	链板厚度 Plate thickness	抗拉强度 Tensile strength	平均抗拉强度 Average tensile strength	每米长重 Weight per meter	型号 Type
	P	d1 max	b1 min	d2 max	d3 min	L max	Lc max	h2 max	t/T max	Q min	Q0	q		
	mm	mm	mm	mm	mm	mm	mm	mm	mm	kN/lbf	kN	kg/m		
HP41.75F3	41.750	17.00	20.50	11.00	8.30	36.00	39.50	21.40	3.00	27.00/6136	28.00	1.62	A	
HP41.75F6	41.750	17.10	20.20	11.11	8.20	36.70	37.50	25.26	3.10	49.00/11015	53.90	2.04	A	
HP50F2	50.000	31.00	15.00	13.20	10.20	36.50	38.00	25.00	4.00	40.00/9091	43.20	3.40	B	
DH16500HP	50.000	30.00	10.50	11.40	8.20	27.40	28.60	26.00	3.10	50.00/11240	53.60	2.23	B	
HB50F4	50.000	30.00	10.00	11.60	8.00	26.60	30.00	25.40	3.00	60.00/13635	67.20	2.03	B	
HB50F1 - C30	50.000	30.00	10.00	12.00	8.20	26.50	28.10	26.00	3.00	45.00/11016	49.50	2.36	B	
HB50.8	50.800	30.00	10.50	11.40	8.20	27.40	28.60	26.00	3.10	50.00/11240	53.60	2.56	B	
HB50.8F4	50.800	30.00	10.50	13.60	8.20	27.40	28.90	26.00	3.10	42.00/9545	48.20	2.28	B	
HB50.8F14	50.800	30.00	10.00	11.60	8.00	26.60	30.00	25.40	3.00	60.00/13635	67.20	2.01	B	
HB60F6	60.000	30.00	10.00	11.60	8.00	26.60	30.00	26.00	3.00	46.00/10341	50.60	2.06	B	
HB60F7	60.000	30.00	10.00	11.60	8.00	26.60	30.00	25.40	3.00	60.00/13635	66.00	1.82	B	
HB63	63.000	30.00	10.00	11.40	8.10	26.70	28.10	26.50	3.10	50.00/11240	53.60	2.07	B	
HB63F1	63.000	40.00	10.00	11.40	8.10	26.70	28.10	26.50	3.10	50.00/11240	53.60	2.27	B	
HB63F2	63.000	40.00	20.00	11.40	8.10	36.70	38.10	26.50	3.10	50.00/11240	53.60	3.20	B	
HB63F3	63.000	40.00	15.00	11.40	8.20	35.60	37.00	26.50	4.00	35.00/7955	38.50	3.90	B	
HB63F4	63.000	30.00	20.00	11.40	8.10	36.70	38.10	26.50	3.10	50.00/11240	53.60	2.97	B	
HB63F6	63.000	30.00	10.00	11.70	8.20	26.70	28.10	26.50	3.10	50.00/11240	56.70	2.08	B	
HB63F7	63.000	40.00	18.00	14.00	10.20	38.00	39.50	28.00	4.00	50.00/11240	56.70	4.26	B	
HB63F8	63.000	30.00	20.00	11.70	8.10	36.50	38.00	26.50	3.10	50.00/11240	56.70	2.91	B	
HB63F14	63.000	30.00	10.00	11.40	8.10	30.20	31.60	26.50	4.00	50.00/11240	55.00	2.45	B	
HB63.5F3	63.500	31.00	15.00	14.00	8.20	31.00	33.00	28.00	3.00	34.00/7647	38.00	2.75	B	
HB80F3	80.000	45.00	20.00	24.00	18.00	39.00	40.60	40.00	3.50	75.00/16858	82.50	4.60	B	
HB100	100.000	30.00	10.50	11.40	8.20	27.40	28.60	26.00	3.10	50.00/11240	53.60	1.56	B	
HB100F8	100.000	30.00	10.00	11.60	8.00	26.60	30.00	25.40	3.00	60.00/13635	67.20	1.37	B	
HB100F16	100.000	35.00	16.00	13.00	8.20	38.60	40.00	30.00	4.00	86.24/19337	95.00	3.26	B	

## 空心销轴输送链 Hollow pin conveyor chains

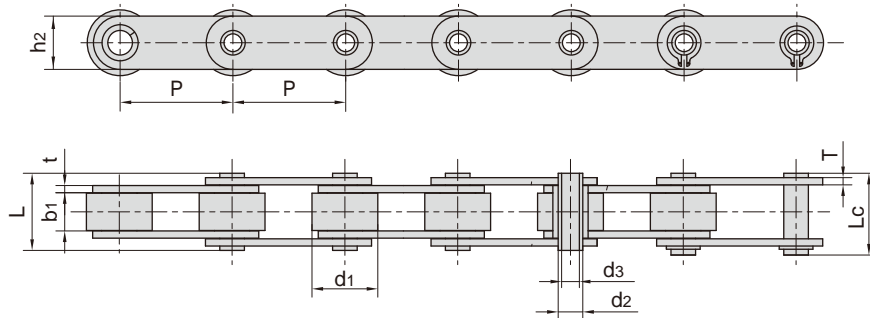

东华链号 Donghua Chain No.	节距 Pitch	滚子直径 Roller diameter	内节内宽 Width between inner plates	销轴直径 Pin diameter		销轴长度 Pin length		内链板高度 Inner plate depth	链板厚度 Plate thickness	抗拉强度 Tensile strength	平均抗拉强度 Average tensile strength	每米长重 Weight per meter
	P	d1 max	b1 min	d2 max	d3 min	L max	Lc max	h2 max	t/T max	Q min	Q0	q
	mm	mm	mm	mm	mm	mm	mm	mm	mm	kN/lbf	kN	kg/m
C12AHB	19.05	11.91	12.70	7.00	5.01	25.50	26.6	18.0	2.42	20.0/4545	22.40	1.58
C12BHP	19.05	12.07	11.68	6.50	4.00	21.60	22.8	15.9	1.85	20.0/4545	22.40	1.22
C2042HP	25.40	15.88	7.85	5.63	4.00	16.50	17.6	12.0	1.50	11.0/2500	12.60	0.78
C2042H-HP	25.40	15.88	7.85	5.63	4.00	18.80	19.9	12.0	2.03	11.0/2500	13.20	0.95
C2052HP	31.75	19.05	9.53	7.22	5.12	20.50	21.8	15.0	2.03	20.4/4636	22.80	1.25
C2052HPF1	31.75	19.05	9.40	7.03	5.12	20.00	21.5	15.3	1.85	15.0/3409	17.30	1.21
C2052HPF3	31.75	19.05	9.53	7.02	5.13	20.10	21.6	15.09	2.03	19.6/4455	21.60	1.20
C2052H-HP	31.75	19.05	9.53	7.22	5.12	22.10	23.4	15.0	2.42	20.4/4545	23.50	1.44
C2062HP	38.10	22.23	12.70	8.31	6.00	25.80	26.8	17.0	2.42	24.0/5455	27.10	1.72
C2062H-HP	38.10	22.23	12.70	8.31	6.00	29.20	30.2	17.0	3.25	24.0/5455	27.60	1.99
C2062H-HPF3	38.10	22.23	12.70	8.31	6.00	25.80	26.8	17.0	2.42	24.0/5455	27.10	1.72
C2082HP	50.80	28.58	15.75	11.40	8.05	32.40	33.8	24.0	3.25	50.0/11364	52.00	2.82
C2082H-HP	50.80	28.58	15.75	11.40	8.05	35.70	37.0	24.0	4.00	50.0/11364	56.50	3.34
C1655HP	50.80	30.00	10.50	13.00	8.20	27.40	28.9	26.0	3.10	42.0/9545	48.20	2.72
63HPF1	63.00	40.00	15.00	16.00	12.10	35.00	36.2	28.5	4.00	50.0/11364	56.70	4.20
C2102HP	63.50	39.67	18.90	13.60	9.50	40.30	42.0	30.0	4.00	60.0/13636	72.00	5.13
DH4202HP	50.80	31.80	15.00	14.00	10.10	36.30	39.0	26.0	3.80	42.0/9545	51.60	3.75
DH4203HP	76.20	31.80	15.00	14.00	10.10	36.30	39.0	26.0	3.80	42.0/9545	47.10	3.01
DH8403HP	76.20	47.60	19.00	19.05	13.60	43.80	46.3	39.0	5.1/3.8	84.3/19159	130.30	6.81
DH42035HP	88.90	31.80	15.00	14.00	10.10	36.30	39.0	26.0	3.80	42.0/9545	51.10	2.79
DH4204HP	101.60	31.80	15.00	14.00	10.10	36.30	39.0	26.0	3.80	42.0/9545	51.60	2.63
DH8404HP	101.60	47.60	19.00	19.05	13.60	43.80	46.3	39.0	5.1/3.8	84.3/19159	130.30	5.78
DH8406HP	152.40	47.60	19.00	19.05	13.60	43.80	46.3	39.0	5.1/3.8	84.0/19091	130.30	5.18
HB25.4F2	25.40	15.89	17.26	9.00	6.35	31.30	32.5	20.0	2.50	20.0/4545	22.40	1.97
HB25.4F4	25.40	20.00	11.00	12.00	8.35	27.00	28.4	24.0	3.00	32.0/7273	35.80	2.48
HB38.1F2	38.10	25.40	12.70	9.50	6.60	26.60	28.0	19.1	2.30	20.0/4545	22.40	2.07
HB38.1F6-R	38.10	25.40	15.20	14.00	10.20	34.50	36.5	27.0	3.70	45.0/10228	49.50	3.20
HB40F1	40.00	22.00	9.00	9.00	6.00	23.00	24.5	18.0	2.50	20.0/4546	22.00	1.58
HB41.4	41.40	25.40	15.00	13.80	10.50	35.50	37.0	32.0	4.00	45.0/10227	48.00	4.20

## 空心销轴输送链 Hollow pin conveyor chains

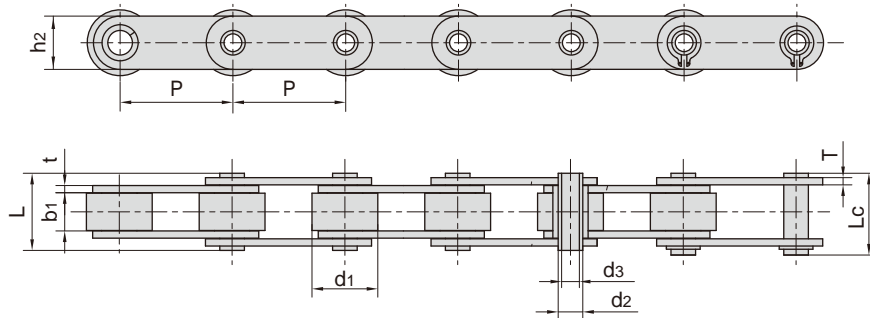

东华链号 Donghua Chain No.	节距 Pitch	滚子直径 Roller diameter	内节内宽 Width between inner plates	销轴直径 Pin diameter		销轴长度 Pin length		内链板高度 Inner plate depth	链板厚度 Plate thickness	抗拉强度 Tensile strength	平均抗拉强度 Average tensile strength	每米长重 Weight per meter
	P	d1 max	b1 min	d2 max	d3 min	L max	Lc max	h2 max	t/T max	Q min	Q0	q
	mm	mm	mm	mm	mm	mm	mm	mm	mm	kN/lbf	kN	kg/m
HB50	50.00	31.00	15.00	14.00	10.20	36.00	37.5	25.0	4.00	40.0/9091	43.20	3.98
HB50F9	50.00	18.00	11.50	8.20	6.00	27.40	28.4	25.0	3.00	15.0/3409	17.30	2.00
HB50F12	50.00	25.00	11.60	9.00	6.20	26.00	27.4	20.0	2.50	20.0/4545	22.40	1.77
HB50.42	50.42	37.30	15.00	14.00	10.20	36.00	37.5	26.2	4.00	40.0/9090	44.80	4.46
HB50.8F3	50.80	30.00	16.00	14.00	9.00	36.40	37.5	25.5	3.1	42.0/9545	47.00	3.20
HB50.8F8	50.80	32.00	20.00	19.10	12.40	44.60	46.4	40.0	5.00/4.00	100.0/22727	108.00	6.75
HB50.8F9	50.80	35.00	12.00	15.50	10.20	36.00	37.3	30.0	5.00	70.0/15909	77.00	4.92
HB50.8F11	50.80	38.10	16.00	13.80	9.70	37.20	39.5	25.4	3.90	57.0/12814	62.70	5.01
HB50.8F12	50.80	28.58	16.00	14.00	9.00	36.40	37.5	25.5	3.50	42.0/9545	47.00	3.26
HB50.8F18	50.80	38.10	16.00	13.80	9.70	37.20	39.5	25.4	4.80/3.90	57.0/12814	62.70	4.85
HB50.8F20	50.80	38.10	15.20	14.28	9.50	36.60	37.2	26.4	4.00	40.0/8992	44.00	4.88
HB50.8F26	50.80	30.00	16.00	14.00	9.00	38.40	39.5	27.0	4.00	60.0/13635	67.20	3.98
HB55F2	55.00	20.00	14.00	9.00	6.00	29.00	31.0	20.0	2.50	18.0/4180	19.20	1.54
HB57	57.00	30.00	10.00	13.00	10.20	26.40	27.5	26.0	3.00	28.0/6298	30.00	1.84
HB63F11	63.00	40.00	20.00	20.00	18.00	42.50	43.5	42.0	4.00	46.0/10454	50.60	5.83
HB63F12	63.00	30.00	10.00	11.40	8.10	26.70	28.1	26.5	3.10	50.0/11364	56.50	2.39
HB63.5F1	63.50	32.00	15.00	16.00	12.20	32.00	33.0	25.0	3.00	20.4/4636	22.80	2.69
HB65	65.00	45.00	20.00	25.00	18.00	38.00	40.0	40.0	3.00	46.0/10454	50.60	4.49
HB65F1	65.00	40.00	20.00	14.00	10.05	40.40	42.0	35.0	4.00	50.0/11364	55.00	5.93
HB75	75.00	40.00	22.00	18.00	12.20	42.00	44.0	35.0	4.00	60.0/13636	72.00	5.57
HB76.2	76.20	31.75	15.50	12.70	9.50	35.50	37.0	26.0	4.00	42.0/9545	49.20	3.25
HB76.2F2	76.20	47.60	20.00	24.00	18.50	44.50	46.1	40.0	5.0/4.0	79.0/17935	92.50	6.77
HB76.2F6	76.20	44.45	23.00	17.48	13.49	44.20	46.5	35.0	4.00	75.0/17044	82.50	6.27
HB76.2F9	76.20	47.60	17.50	22.00	16.60	46.00	47.6	38.0	6.00	56.0/12596	61.50	7.52
HB80	80.00	50.00	20.00	24.00	18.50	44.50	46.1	40.0	5.0/4.0	79.0/17953	92.50	6.81
HB80F4	80.00	50.00	20.00	24.00	18.50	50.50	51.8	40.0	6.00	120.0/26977	132.00	8.10
HB86	86.00	45.00	15.00	19.00	14.50	40.00	41.5	35.0	5.00/4.00	85.0/19119	95.00	5.14
HB100F3	100.00	30.00	24.00	15.95	10.30	46.00	47.3	35.0	4.00	75.0/17046	84.70	4.04
HB100F6	100.00	60.00	31.00	27.00	19.00	59.00	60.8	50.0	6.00/5.00	150.0/34088	160.00	11.50

## 空心销轴输送链 Hollow pin conveyor chains

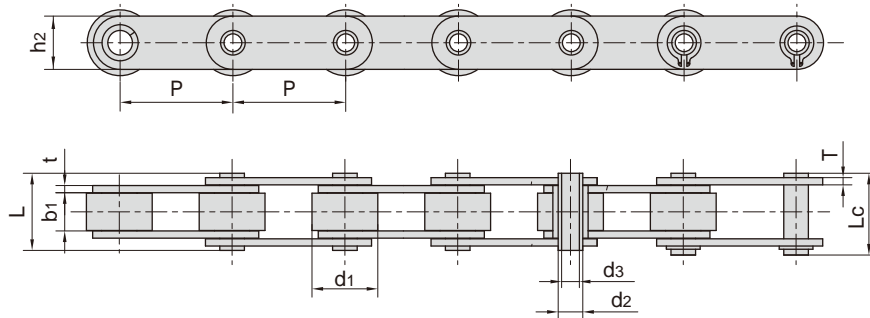

东华链号 Donghua Chain No.	节距 Pitch	滚子直径 Roller diameter	内节内宽 Width between inner plates	销轴直径 Pin diameter		销轴长度 Pin length		内链板高度 Inner plate depth	链板厚度 Plate thickness	抗拉强度 Tensile strength	平均抗拉强度 Average tensile strength	每米长重 Weight per meter
	P	d1 max	b1 min	d2 max	d3 min	L max	Lc max	h2 max	t/T max	Q min	Q0	q
	mm	mm	mm	mm	mm	mm	mm	mm	mm	kN/lbf	kN	kg/m
HB100F7	100.00	30.00	15.00	16.00	12.30	36.50	37.8	35.0	4.00	75.0/17046	84.70	3.49
HB100F9	100.00	45.00	32.80	18.00	12.40	49.00	49.0	35.0	5.00	75.0/17046	84.70	6.14
HB100F10	100.00	45.00	22.00	18.00	12.10	48.50	49.7	35.0	5.00	75.0/17046	84.70	6.05
HB100F11	100.00	40.00	20.60	16.00	12.50	42.10	43.4	35.0	4.00	75.0/17046	84.70	4.58
HB100F13	100.00	48.00	25.00	16.00	11.30	51.00	52.8	35.0	5.00	95.0/21356	104.50	7.03
HB100F14	100.00	37.70	22.20	18.00	12.40	45.30	46.3	35.0	4.15	64.0/14395	70.00	4.79
HB100F18	100.00	31.80	17.00	14.00	10.40	39.50	41.0	26.0	3.80	42.0/9545	47.00	2.82
HB100F19	100.00	40.00	22.00	18.00	12.20	44.70	45.9	35.0	4.00	75.0/16869	82.50	5.18
HB100F20	100.00	38.00	19.00	21.00	13.00	48.00	48.0	50.0	4.80	112.0/25192	123.20	6.60
HB125	125.00	70.00	37.00	26.00	16.20	73.50	75.0	60.0	7.00	250.0/56202	275.00	17.56
HB127F1	127.00	66.70	25.40	26.90	20.10	62.00	64.0	50.0	6.30	107.0/24067	118.00	11.30
HB150F1	150.00	60.00	22.00	24.00	18.00	49.50	51.5	45.0	5.00	100.0/22727	110.00	7.55
HB152F3	152.00	70.00	24.50	26.00	20.00	55.00	57.0	51.0	6.00	150.0/33721	165.00	11.60
HP40	40.00	22.00	8.75	9.00	6.00	23.00	24.2	18.0	2.50	27.0/4545	28.00	1.49
HP50	50.00	31.00	14.50	13.20	10.40	31.10	32.5	25.0	3.10	30.0/6818	34.20	3.29
HP50F4	50.00	31.00	15.00	13.20	10.20	36.50	38.0	25.0	4.00	40.0/9091	44.80	3.73
HP50.8	50.80	26.00	15.88	20.00	14.30	41.00	42.2	38.1	4.80	100.0/22727	108.00	5.32
HP76.2F7	76.20	38.00	17.00	15.00	9.53	43.50	44.6	30.0	5.00	90.0/20243	99.00	4.85
HP76.2F9	76.20	44.45	26.00	17.80	12.50	51.70	52.4	39.0	5.10/4.00	84.3/18961	92.50	7.64
HP100	100.00	45.00	22.00	16.00	12.00	46.00	47.5	35.0	5.00	75.0/17044	90.00	6.20
HP100F1	100.00	45.00	22.00	18.00	12.00	47.20	48.5	35.0	5.00	75.0/17044	90.00	6.15
HP101.6F1	101.60	47.60	19.00	19.00	13.20	46.20	48.0	40.0	5.00/4.00	53.0/12045	58.20	6.09
HP101.6F2	101.60	66.70	25.40	26.90	20.10	59.20	60.7	51.0	7.10/5.10	150.0/34088	160.00	14.23
HP101.6F6	101.60	47.60	20.50	21.00	16.11	45.00	46.5	40.0	5.00/4.00	60.0/13488	66.00	6.20
HP101.6F8	101.60	63.50	27.50	19.05	13.10	60.70	65.5	50.8	6.40	120.0/26977	132.00	13.12
HP130	130.00	40.00	21.00	18.10	12.10	41.30	42.5	35.0	3.80	80.0/18183	89.60	4.21
HP152	152.40	66.70	25.40	26.90	19.56	57.20	59.5	50.8	7.10/5.10	94.0/21362	107.80	9.90
HP152.4F1	152.40	47.60	19.00	19.00	13.20	46.20	48.0	40.0	5.00/4.00	54.0/12270	59.50	5.00
HP152.4F4	152.40	64.00	25.40	29.00	21.00	59.50	60.1	50.0	8.00/5.00	71.3/16028	78.43	9.82



# 空心销轴输送链 Hollow pin conveyor chains

A型  
Type A

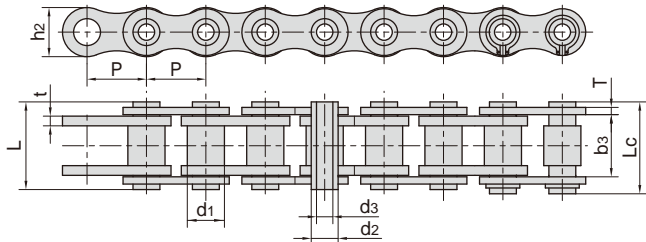

B型  
Type B

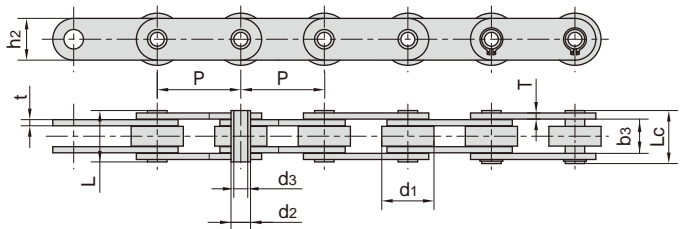

东华链号 Donghua Chain No.	节距 Pitch	滚子直径 Roller diameter	外节内宽 Width between outer plates	销轴直径 Pin diameter		销轴长度 Pin length		内链板高度 Inner plate depth	链板厚度 Plate thickness	抗拉强度 Tensile strength	平均抗拉强度 Average tensile strength	每米长重 Weight per meter	型号 Type
	P mm	d1 max mm	b3 min mm	d2 max mm	d3 min mm	L max mm	Lc max mm	h2 max mm	t/T max mm	Q min kN/lbf	Q0 kN	q kg/m	
08BHPF2	12.700	8.51	13.20	6.65	5.20	18.00	19.2	11.8	1.6/1.3	10.0/2273	11.4	0.50	A
08BHPF3	12.700	8.51	13.40	6.65	4.00	19.00	20.2	11.8	1.70	14.0/3182	16.8	0.69	A
HB12.7	12.700	8.51	13.40	6.65	4.10	19.00	20.2	11.8	1.70	14.0/3182	16.8	0.69	A
08BHPF8	12.700	8.51	11.30	6.30	4.50	16.70	18.5	11.8	1.60	11.0/2500	12.1	0.80	A
40HPF1-D3	12.700	8.51	11.60	6.35	4.36	20.60	20.6	12.0	1.50	11.0/2500	12.1	0.77	A
41HP	12.700	7.77	9.20	5.63	4.19	13.75	16.0	9.91	1.30	4.0/899	4.4	0.35	A
10BHPF1	15.875	10.16	13.41	7.03	5.00	19.20	20.2	14.0	1.85	17.0/3864	20.6	0.83	A
10BHPF2	15.875	10.16	10.40	7.03	5.00	17.00	18.0	14.0	1.85	15.0/3409	17.3	0.74	A
50HPF1	15.875	10.16	13.60	7.03	5.13	20.70	21.9	14.4	2.03	18.0/4091	21.6	0.92	A
12BHPF1	19.050	12.07	16.00	8.03	5.40	22.70	23.9	15.8	1.85	25.0/5682	28.8	1.09	A
60HPF2	19.050	11.91	11.23	5.63	4.05	16.50	17.6	10.4	1.50	10.0/2273	10.8	0.62	A
C12BHPF9	19.050	12.07	15.80	8.03	5.00	22.40	23.9	16.1	1.85	25.0/5682	28.8	1.26	B
12BHPF9	19.050	12.07	15.80	8.03	5.00	22.40	23.9	16.1	1.85	25.0/5682	28.8	1.18	A
60HPF3	19.050	11.91	17.20	8.40	6.10	24.70	26.0	18.0	2.03	20.0/4546	24.0	1.54	A
16BHPF1	25.400	15.88	25.58	11.50	8.10	36.50	37.6	21.0	4.15/3.10	45.0/10227	52.2	2.21	A
HB38.1F7	38.100	22.20	17.50	11.00	8.30	25.00	26.6	18.0	2.50	20.0/4545	22.4	1.46	A
HB38.1F9	38.100	18.00	22.60	14.00	10.00	32.50	34.5	26.5	3.00	40.0/9090	44.0	2.40	B
HP38.1F10	38.100	17.95	23.50	13.60	10.44	36.00	37.3	28.4	3.70	70.0/15736	77.0	2.66	A
32BHP	50.800	29.21	45.70	24.10	18.25	66.00	68.0	42.0	7.00/6.00	155.0/34864	170.0	7.40	A
63HP	63.000	40.00	23.50	16.00	12.00	35.30	38.3	28.6	4.00	65.0/14773	71.5	4.14	B
63HPF2	63.000	40.00	25.80	14.00	8.08	39.10	41.1	20.0	5.00	50.0/11364	65.7	4.17	B
63HPF4	63.000	40.00	23.50	16.00	12.20	34.70	37.7	28.6	4.00	44.0/10000	57.2	4.13	B
63HPF6	63.000	40.00	28.94	16.00	10.30	41.80	43.4	28.6	4.00	44.0/10000	57.2	5.18	B
63HPF11	63.000	40.00	23.50	16.00	12.20	34.70	37.7	28.6	4.00	65.0/147333	71.5	4.25	B
63HPF12	63.000	40.00	23.50	16.00	12.20	34.70	37.7	28.0	4.00	44.0/10000	57.2	4.02	B
HB63F17	63.000	40.00	23.40	18.00	12.20	37.00	38.0	25.0	4.00	40.0/9090	44.0	4.13	B
C2122HPF1	76.200	47.60	29.00	17.81	12.70	43.30	44.7	38.1	4.80	53.3/12123	59.2	7.05	B
HP101.6F6	101.600	47.60	30.50	21.00	16.11	45.00	46.5	40.0	5.00/4.00	60.0/13636	72.0	6.20	B
HP130	130.000	40.00	29.20	18.10	12.10	41.30	42.5	35.0	3.80	80.0/17994	88.0	3.90	B
HP150F1	150.000	60.00	43.50	24.00	18.20	59.00	61.0	45.0	5.00	140.0/31490	154.0	8.52	B