

板式链 Leaf chains

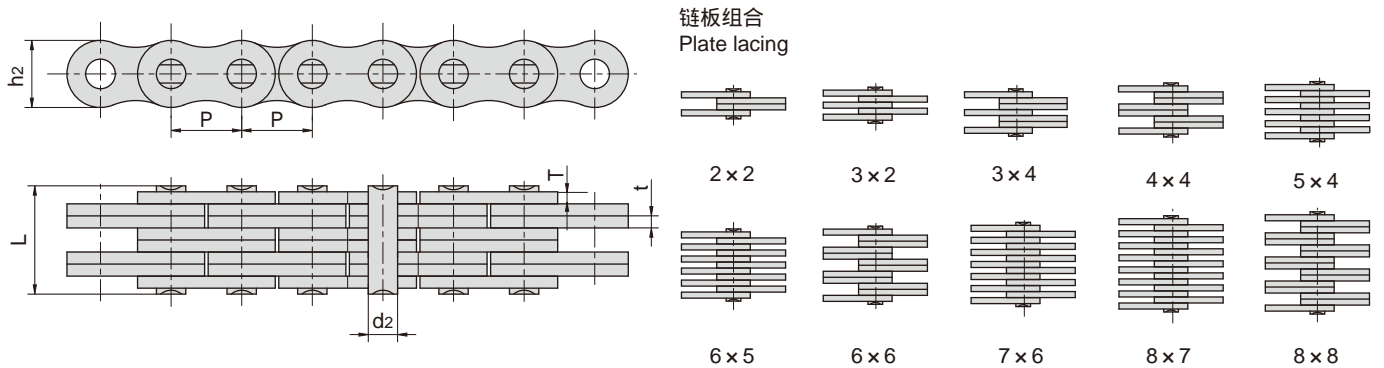

东华链号 Donghua Chain No.	节距	链板组合	链板高度	链板厚度	销轴直径	销轴长度	抗拉强度	平均抗拉强度	每米长重
	Pitch	Plate lacing	Plate depth	Plate thickness	Pin diameter	Pin length	Tensile strength	Average tensile strength	Weight per meter
	P		h2 max	t/T max	d2 max	L max	Q min	Q0	q
	mm		mm	mm	mm	mm	kN/lbf	kN	kg/m
FL644	5.940	4 × 4	4.7	0.60	1.85	6.2	6.50/1477	7.8	0.13
FL666		6 × 6				9.3	9.75/2216	11.8	0.20
FL688		8 × 8				12.0	13.00/2955	15.6	0.25
FL523	8.000	3 × 2	6.3	1.00	2.31	6.7	7.00/1575	7.4	0.18
*FL523F1	8.000	3 × 2	6.3	1.30/1.00	2.31	6.3	7.00/1575	7.4	0.25
*FL523F3	8.000	3 × 2	7.6	1.30/1.04	3.10	8.0	7.00/1575	8.0	0.33
*FL523F4	8.000	3 × 2	7.6	1.30/1.04	2.31	7.6	7.00/1576	8.0	0.32
FL844	8.000	4 × 4	6.9	0.73	2.31	7.9	10.00/2273	12.1	0.25
*FL823F1	8.000	3 × 2	7.6	1.30/1.04	3.15	7.8	11.00/2472	11.8	0.32
FL922	9.525	2 × 2	8.7	1.04	3.28	6.2	10.00/2273	12.1	0.22
FL944		4 × 4				10.4	21.00/4724	24.7	0.43
FL945		4 × 5				11.5	21.00/4724	23.0	0.50
FL956		6 × 5				14.0	25.50/5732	28.0	0.60
FL966		6 × 6				14.9	31.00/7045	36.8	0.65
FL988		8 × 8				19.0	42.00/9450	46.2	0.87
FL966F3		6 × 6				16.2	33.10/7441	36.5	0.75
FL922F4	2 × 2	8.6	12.50/2810	13.8	0.37				
LF10	10.000	3 × 3	7.5	1.20	3.20	10.6	14.00/3150	15.5	0.39
LF1234	12.000	4 × 3	10.0	2.03	3.96	17.6	15.45/3476	17.0	0.85
LF1246	12.000	6 × 4	10.8	1.60	5.08	18.7	30.00/6748	33.0	1.05
F1266F1	12.700	6 × 6	9.0	1.60	3.70	21.6	45.00/10123	50.0	0.92
F122	12.700	2 × 2	8.2	1.00	3.58	7.0	11.43/2598	13.6	0.19
F1223	12.700	3 × 2	10.2	2.03	4.45	12.8	20.00/4545	23.8	0.61
FL1244	12.700	4 × 4	10.2	1.70	4.45	16.7	44.00/10000	52.3	0.83
F1023	15.875	3 × 2	14.3	2.42	4.75	15.9	25.00/5625	27.5	1.11
FLC534	15.875	3 × 4	12.7	1.85	5.08	15.3	40.40/9181	44.4	0.99
FLC545		5 × 4				19.2	54.30/12340	59.7	1.27
FLC556		6 × 5				22.7	67.60/15363	74.3	1.54
FLC567		7 × 6				26.8	80.80/18176	89.0	1.82

注：带*表示链板为直边形；带 表示链板组合特殊
 Note: * means straight link plate; means special link plate combination

板式链 Leaf chains

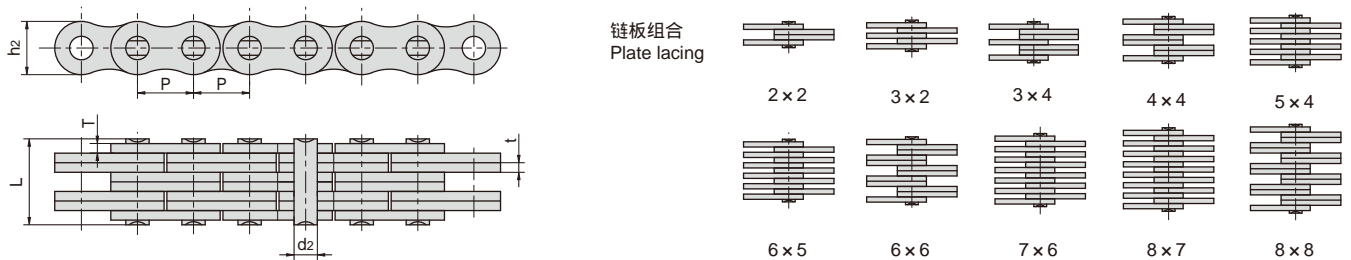

东华链号 Donghua Chain No.	节距 Pitch	链板组合 Plate lacing	链板高度 Plate depth	链板厚度 Plate thickness	销轴直径 Pin diameter	销轴长度 Pin length	抗拉强度 Tensile strength	平均抗拉强度 Average tensile strength	每米长重 Weight per meter				
	P		h2 max	t/T max	d2 max	L max	Q min	Q0	q				
	mm		mm	mm	mm	mm	kN/lbf	kN	kg/m				
FLC578	15.875	8 × 7	12.70	1.85	5.08	30.8	90.0/20250	99.0	2.10				
CTL566	15.875	6 × 6	15.10	2.10	5.08	28.0	78.0/17534	86.0	2.44				
CTBLL588	15.875	8 × 8	14.80	1.70	5.94	30.7	85.0/19108	105.0	2.59				
*CH25	17.000	2 × 1	9.00	1.60	4.00	7.5	6.0/1348	7.5	0.27				
LF1866	18.550	6 × 6	15.80	3.00	6.00	39.8	106.0/23845	116.6	3.58				
LF1966	19.050												
F19S-44	19.050	4 × 4	14.70	2.25	5.98	21.8	76.5/17210	84.5	1.55				
F19S-66		6 × 6				31.0	115.0/25870	126.5	2.31				
F19V-44	19.050	4 × 4	15.20	2.42	6.50	22.4	71.0/16136	84.3	1.73				
F19V-66		6 × 6				32.3	106.0/24090	125.9	2.57				
F19VF1-66	19.050	6 × 6	17.60	2.42	6.50	32.3	164.0/36867	180.4	3.22				
F19V-88	19.050	8 × 8	15.20	2.42	6.50	42.4	142.0/31922	156.2	3.41				
FLC623	19.050	3 × 2	14.50	1.85	5.72	12.5	30.0/6744	33.0	0.81				
FLC634	19.050	4 × 3	14.50	1.85	5.72	16.1	46.0/10341	50.6	1.12				
FL2044	20.000	4 × 4	16.00	2.42	5.30	22.4	67.0/15062	73.7	1.83				
FLC823	25.400	3 × 2	19.46	3.25	8.28	20.9	65.0/14612	72.0	1.86				
FLC834		4 × 3				27.4	100.0/22500	110.0	2.57				
FLC845		5 × 4				34.2	130.0/29224	143.0	3.30				
FLC856		6 × 5				40.5	166.0/37343	183.0	4.00				
FLC867		7 × 6				47.0	195.7/44024	215.3	4.70				
FLC878		8 × 7				53.6	227.5/51180	250.5	5.40				
F25-34		25.400				3 × 4	23.40	3.05/4.00	10.85	28.6	125.0/28120	137.5	3.64
F25-66	6 × 6		44.1	250.0/56240	275.0	5.93							
F25-66F1	25.000	6 × 6	24.00	3.00	10.85	42.0	147.0/33046	190.0	5.65				
FLC1034	31.750	4 × 3	25.40	3.25	9.53	28.4	82.7/18591	91.0	3.52				
FLC1045		5 × 4				34.3	110.0/24745	121.0	4.49				
FLC1056		6 × 5				40.6	137.9/31340	151.0	5.44				
FLC1067		7 × 8				47.2	165.4/37590	181.9	6.42				
FLC1078		8 × 7				53.8	193.0/43863	212.0	7.40				
LF31109		31.750				10 × 9	27.00	4.00	12.00	83.0	440.0/98915	500.0	12.70
P35-44		35.000				4 × 4	30.00	4.00	12.00	37.7	100.0/22500	110.0	5.96
LF8844F1	88.900	4 × 4	84.00	13.50	40.00	122.0	1950.0/438360	2145.0	60.60				
D90F1	90.000	8 × 8	70.00	6.30	36.00	113.0	980.0/220460	1078.0	41.20				
LF105	105.000	11 × 10	80.00	6.00	40.00	143.0	1470.0/330690	1690.5	64.38				

注：*表示链板为直边形；带 表示链板组合特殊
Note: * means straight link plate; means special link plate combination

板式链 Leaf chains

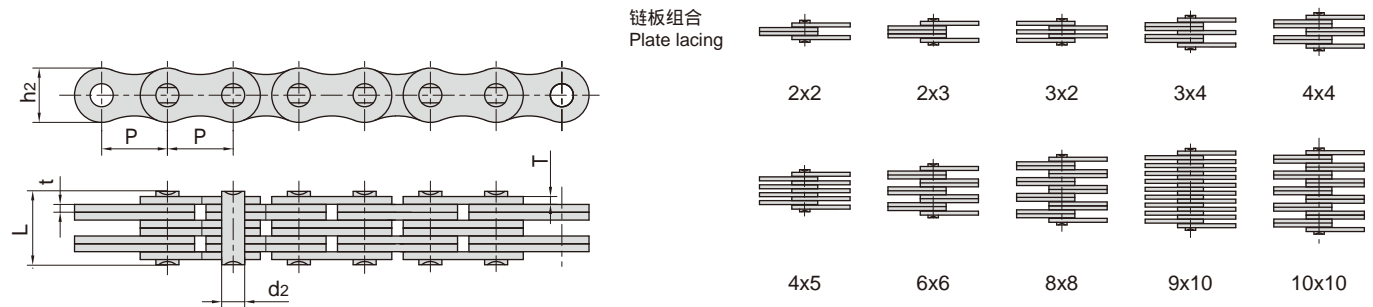

东华链号 Donghua Chain No.	节距 Pitch	链板组合 Plate lacing	链板高度 Plate depth	链板厚度 Plate thickness	销轴直径 Pin diameter	销轴长度 Pin length	抗拉强度 Tensile strength	平均抗拉强度 Average tensile strength	每米长重 Weight per meter
	P		h ₂ max	t/T max	d ₂ max	L max	Q min	Q ₀	q
	mm		mm	mm	mm	mm	kN/lbf	kN	kg/m
AL0522	8.000	2 × 2	7.10	0.80	2.31	5.00	4.4/990	4.6	0.15
AL0544		4 × 4				8.20	8.8/1980	9.3	0.28
AL0566		6 × 6				11.60	13.0/2922	13.7	0.42
AL322F1	9.525	2 × 2	7.00	1.30	3.58	7.50	9.3/2092	9.8	0.22
AL344F1		4 × 4				12.80	18.5/4162	19.4	0.42
AL366F1		6 × 6				18.20	27.8/6254	29.2	0.62
AL388F1		8 × 8				23.60	37.0/8323	38.8	0.82
AL322HF2	9.525	2 × 2	7.70	1.50	3.58	7.60	10.0/2248	10.5	0.24
*AL344F3	9.525	4 × 4	7.70	1.20	3.58	11.60	18.0/4046	18.9	0.49
AL344F4	9.525	4 × 4	7.90	1.57	3.58	15.00	25.0/5620	26.3	0.63
AL866F1	25.400	6 × 6	20.50	3.00	7.92	40.30	135.0/30370	148.5	4.40
AL822F3	25.400	2 × 2	20.80	3.25	7.92	15.90	57.9/13016	70.0	1.61
AL10910F1	31.750	10 × 9	27.00	4.00	12.00	83.00	400.0/89923	441.0	11.80
AL1066F2	31.750	6 × 6	25.60	4.00	9.53	52.20	265.0/59574	305.0	7.43
AL1044F1	31.750	4 × 4	22.80	4.15	10.19	37.90	214.0/48107	234.5	4.32
AL1266F1	38.100	6 × 6	30.00	4.80	13.30	64.30	420.0/94482	462.0	9.68
BL432F1	12.700	3 × 2	11.60	2.03	4.45	12.60	22.0/4946	24.0	0.76
LH0844F5	12.700	4 × 4	12.07	1.60	5.08	16.00	27.5/6182	30.0	1.01
LH0832F6	12.700	3 × 2	12.07	2.03	4.45	13.16	19.8/4451	23.0	0.77
LH081010F8	12.700	10x10	12.07	2.03	5.94	44.80	120.0/26977	130.0	6.35
LH0844F	12.700	4 × 4	12.07	1.60	5.08	15.70	44.48/10000	48.9	1.01
BL544F1	15.875	4 × 4	14.60	2.37	5.94	22.50	80.0/17985	85.0	1.76
LH1034F2	15.875	3 × 4	15.00	2.42	5.94	20.30	65.0/14612	70.0	1.64
BL544F8	15.875	4 × 4	15.00	1.70	5.80	17.00	46.0/10341	53.0	1.33
LH1223F1	19.050	2 × 3	15.60	2.42	5.94	20.30	29.4/6610	32.5	1.50
LH1245F1		4 × 5				25.20	39.2/8812	43.0	1.91
LH1223F3	19.050	2 × 3	18.10	3.25	7.93	19.90	68.65/15433	71.0	1.95
LH1234F3		3 × 4				26.60	102.97/23148	108.8	2.69

注：带*表示链板为直边形；带 表示链板组合特殊
 Note: * means straight link plate; means special link plate combination

板式链 Leaf chains

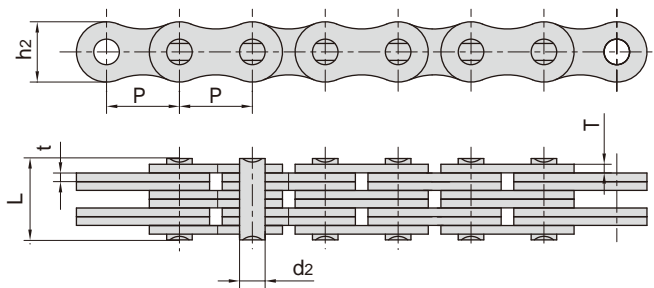

链板组合
Plate lacing

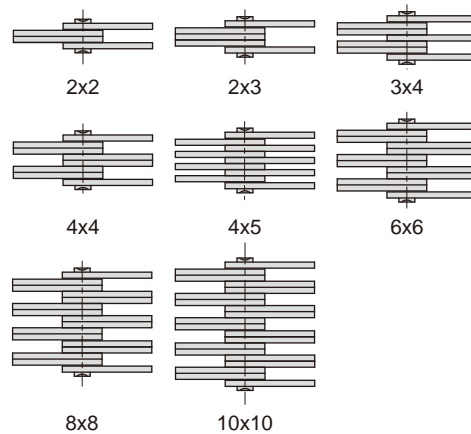

东华链号 Donghua Chain No.	节距	链板组合	链板高度	链板厚度	销轴直径	销轴长度	抗拉强度	平均抗拉强度	每米长重
	Pitch	Plate lacing	Plate depth	Plate thickness	Pin diameter	Pin length	Tensile strength	Average tensile strength	Weight per meter
	P		h ₂ max	t/T max	d ₂ max	L max	Q min	Q ₀	q
	mm		mm	mm	mm	mm	kN/lbf	kN	kg/m
BL666F1	19.050	6 x 6	18.10	2.35	6.50	31.70	130.0/29224	143.0	3.30
*BL666GL	19.050	6 x 6	16.00	3.00	6.25	40.00	100.0/22480	110.0	3.80
BL866F1	25.400	6 x 6	24.10	3.10/4.00	10.85	45.70	200.0/44992	220.0	6.14
BL834F2		3 x 4				29.50	120.0/26995	132.0	3.76
BL834F3	25.400	3 x 4	24.10	4.00	10.90	32.90	142.0/31944	156.2	4.44
BL866F3		6 x 6				52.20	253.6/57050	279.0	7.48
BL834F5	25.400	3 x 4	24.10	3.10/4.00	10.90	28.00	120.0/26995	132.0	3.64
BL866F5	25.400	6 x 6	24.10	3.30/4.00	10.90	45.30	200.0/44992	220.0	4.94
LH1646F3	25.400	4 x 6	24.10	4.00	9.53	44.20	233.0/52378	256.5	6.22
BL844F8	25.400	4 x 4	25.10	3.00	10.90	30.00	120.0/26976	135.0	3.84
LH2066F1	31.750	6 x 6	29.70	4.09	11.10	55.70	303.0/68177	365.0	9.42
BL1046F2	31.750	4 x 6	29.70	4.00	11.10	47.00	231.3/51996	266.0	7.74
LH2054F4	31.750	5 x 4	29.70	5.60	11.10	56.50	280.0/62947	340.0	9.56
LH281010F1	44.450	10x10	36.10	5.00	14.27	108.00	1220.0/274256	1400.0	22.20
LH3288F1	50.800	8 x 8	47.80	6.90	20.20	122.00	1200.0/269950	1320.0	33.53
LH3266F2	50.800	6 x 6	48.20	7.00	17.46	91.80	867.0/195040	953.7	24.52
LH3244F6	50.800	4 x 4	42.00	6.00	17.46	56.00	430.0/96667	505.0	11.96
LH3288F9	50.800	8 x 8	48.20	6.40	17.46	112.00	1040.0/233792	1144.0	31.89
LH3288F10	50.800	8 x 8	48.20	9.50	19.84	164.20	2100.0/472080	2310.0	51.63
LL0622F4	9.525	2 x 2	8.40	1.04	3.28	6.20	10.0/2248	10.5	0.23
LL0634F4		3 x 4				9.70	15.5/3484	16.5	0.39
LL0644F4		4 x 4				10.70	21.0/4720	22.0	0.44
LL0666F4		6 x 6				14.90	31.0/6970	33.0	0.65

注：带*表示链板为直边形；带 表示链板组合特殊
Note: * means straight link plate; means special link plate combination

板式链 Leaf chains

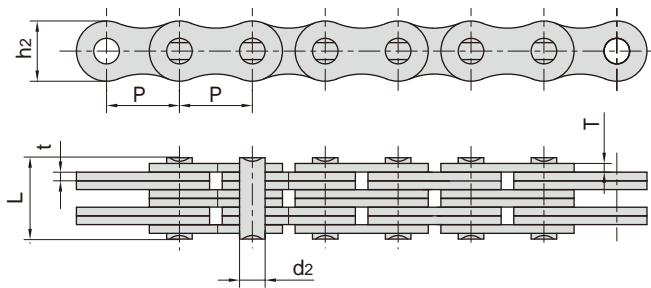

链板组合
Plate lacing

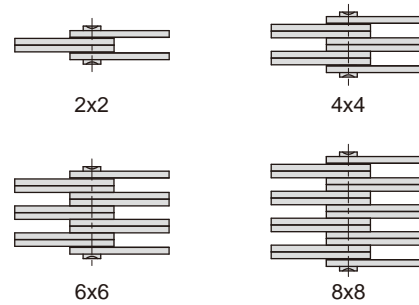

东华链号 Donghua Chain No.	节距 Pitch	链板组合 Plate lacing	链板高度 Plate depth	链板厚度 Plate thickness	销轴直径 Pin diameter	销轴长度 Pin length	抗拉强度 Tensile strength	平均抗拉强度 Average tensile strength	每米长重 Weight per meter
	P		h ₂ max	t/T max	d ₂ max	L max	Q min	Q ₀	q
	mm		mm	mm	mm	mm	kN/lbf	kN	kg/m
LL0622F7	9.525	2 x 2	8.20	1.30	3.28	7.40	10.5/2360	11.6	0.27
LL0644F7		4 x 4				12.80	21.0/4720	23.0	0.52
LL0844F6	12.700	4 x 4	11.00	1.50	4.45	14.60	37.6/8452	81.4	0.82
LL0888F1		8 x 8				27.40	77.0/17310	85.0	1.61
LL0844F7	12.700	4 x 4	11.20	1.60	4.45	15.60	36.4/8180	41.5	0.85
LL0822F13	12.700	2 x 2	10.60	1.70	4.45	9.40	22.0/4940	23.0	0.45
LL0844F13		4 x 4				16.50	40.0/8990	43.0	0.88
LL0888F2	12.700	8 x 8	11.00	1.43	4.45	25.90	77.0/17310	84.7	1.55
LL1044F7	15.875	4 x 4	13.70	1.50	5.08	15.10	48.0/10790	52.8	1.04
LL1066F3	15.875	6 x 6	13.70	1.80	5.08	24.50	86.0/19333	94.6	1.68
LL101212F4	15.875	12x12	11.80	1.60	5.08	42.50	110.0/24728	121.0	2.47
LL101212F5	15.875	12x12	13.70	1.50	5.08	40.50	136.2/30620	150.0	3.00
LL1266F2	19.050	6 x 6	14.50	3.00	5.72	39.50	156.8/35249	173.0	3.03
LL1266F3	19.050	6 x 6	16.00	3.00	5.72	39.50	88.5/19895	97.5	3.03
*LL1266H	19.050	6 x 6	16.13	3.00	5.72	40.00	86.7/19490	100.0	3.75
LL1266F6	19.050	6 x 6	18.50	2.90	5.72	38.75	88.2/19827	97.0	4.12
LL1622F6	25.400	2 x 2	20.00	3.00	8.28	15.60	58.0/13047	63.8	1.40
LL2066F6	31.750	6 x 6	30.20	4.00	13.74	56.10	310.0/69690	356.5	13.13
LL3244F2	50.800	4 x 4	43.10	6.00	17.76	54.00	520.0/116978	572.0	12.62
LL3244F8	50.800	4 x 4	42.00	6.00	17.81	57.00	520.0/116900	560.0	12.31
LL3288F8		8 x 8				105.50	1040.0/233800	1125.0	24.32
LL4088F2	63.500	8 x 8	52.70	8.20	22.89	140.00	1440.0/323725	1660.0	42.39
LL4888H	76.200	8 x 8	70.00	12.00	36.50	204.00	2630.0/591638	2893.0	83.80

注：带*表示链板为直边形；带 表示链板组合特殊
Note: * means straight link plate; means special link plate combination

板式链 Leaf chains

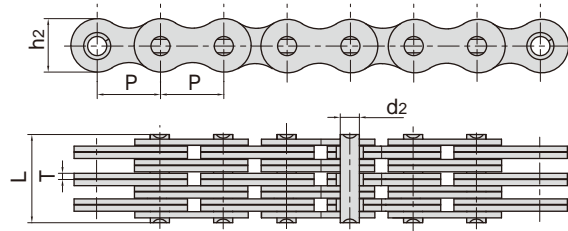

东华链号 Donghua Chain No.	节距 Pitch	链板组合 Plate lacing	链板高度 Plate depth	链板厚度 Plate thickness	销轴直径 Pin diameter	销轴长度 Pin length	抗拉强度 Tensile strength	平均抗拉强度 Average tensile strength	每米长重 Weight per meter
	P mm		h2 max mm	T max mm	d2 max mm	L max mm	Q min kN/lbf	Q0 kN	q kg/m
FB156	15.875	6 × 6	14.7	1.70	5.08	24.0	78.0/17550	86.0	1.91
FB156S				2.03		27.5	83.5/18784	92.0	2.24
FB196	19.050	6 × 6	16.0	1.85	5.72	25.4	95.0/21371	105.0	1.94
FB196S				2.42		32.3	130.0/29244	143.0	3.37

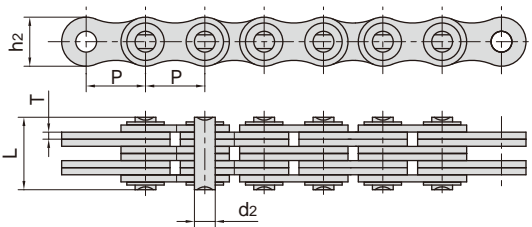

链板组合
Plate lacing

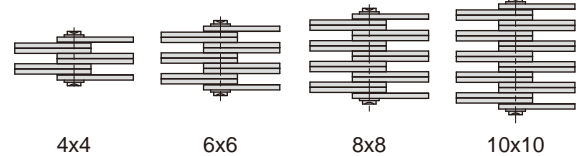

东华链号 Donghua Chain No.	节距 Pitch	链板组合 Plate lacing	链板高度 Plate depth	链板厚度 Plate thickness	销轴直径 Pin diameter	销轴长度 Pin length	抗拉强度 Tensile strength	平均抗拉强度 Average tensile strength	每米长重 Weight per meter
	P mm		h2 max mm	T max mm	d2 max mm	L max mm	Q min kN/lbf	Q0 kN	q kg/m
BL1266F1	38.1	6 × 6	35.7	5.6	12.70	78.9	453.7/102063	499.0	15.69
BL1666F4	50.8	6 × 6	48.2	7.2	17.46	99.2	867.0/195040	953.7	27.27
LL2488F1	38.1	8 × 8	33.4	5.0	14.63	94.0	680.0/152864	748.0	16.71
LL3244F1	50.8	4 × 4	42.0	6.0	17.81	61.6	520.0/116978	572.0	12.90
LL3266F1		6 × 6				86.0	780.0/175467	858.0	18.90
LL3288F1		8 × 8				110.0	1040.0/233956	1144.0	24.89
LL321010F1		10 × 10				134.3	1300.0/292445	1430.0	30.89
LL3244F3	50.8	4 × 4	43.1	6.0	17.76	60.0	520.0/116978	572.0	13.06
LL3266F3		6 × 6				84.4	780.0/175467	858.0	19.44
LL3288F3		8 × 8				108.6	1040.0/233956	1144.0	25.43
LL3244F4	50.8	4 × 4	42.0	6.4	17.81	67.5	520.0/116980	572.0	13.82
LL3266F4		6 × 6				92.8	780.0/175467	858.0	20.17
LL3288F7		8 × 8				117.0	1040.0/233800	1144.0	26.30
LL4066F1	63.5	6 × 6	57.5	6.3	19.85	100.0	1166.2/262162	1283.0	29.30
LL4088F1		8 × 8				126.0	1558.2/350283	1714.0	38.10
LL4088F3	63.5	8 × 8	57.5	6.0	19.85	119.0	1395.0/313596	1535.0	35.79
LL4044F4	63.5	4 × 4	52.7	8.0	22.89	80.8	780.0/175351	860.0	21.82
LL4888F3	76.2	8 × 8	73.0	7.2	34.67	138.5	1840.0/413632	2024.0	56.02
LL481010F3		10 × 10				165.5	2340.0/526032	2574.0	69.18

板式链 Leaf chains

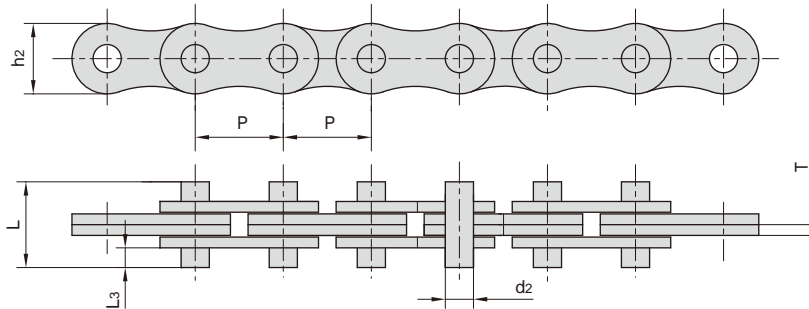

东华链号 Donghua Chain No.	节距	链板高度	链板厚度	销轴直径	销轴长度		抗拉强度	平均抗拉强度	每米长重
	Pitch	Plate depth	Plate thickness	Pin diameter	Pin length		Tensile strength	Average tensile strength	Weight per meter
	P	h2 max	T max	d2 max	L max	L3	Q min	Q0	q
	mm	mm	mm	mm	mm	mm	kN/lbf	kN	kg/m
AL422F1 - D2	12.700	11.00	1.60	3.96	14.4	3.80	14.1/3172	15.5	0.50
AL522 - D2	15.875	12.80	2.03	5.10	16.0	3.90	22.0/4950	23.0	0.69
AL522 - D2F1					19.0	5.40			
AL522F1 - D2	15.800	12.70	2.00	5.09	16.1	3.90	30.38/6834	32.0	0.66
AL622 - DD3F1	19.050	16.90	3.25	5.94	22.3	4.40	50.0/11240	55.0	1.44
AL644F4 - D2	19.050	14.60	3.10	5.90	22.5	4.90	36.0/8093	40.0	1.14
BL422 - DD3	12.700	12.07	2.03	5.08	31.4	11.50	22.24/50000	24.5	0.91
LH1222 - D2	19.050	18.10	3.25	7.92	22.6	4.60	48.93/11000	54.0	1.66
LH1222F7 - DD3					29.4	8.00	48.93/11001	55.0	1.80
LH1222 - DD3F1					29.0	7.75	48.93/10999	53.8	1.80
LH1246 - DD3F1					42.5	4.75	97.9/22008	112.5	3.88
LH1622F1	25.400	24.10	4.00	9.53	34.0	8.80	84.5/19010	93.0	2.40
LH1622 - D2					36.0	9.80			2.83
LH1622 - DD3F1					45.0	14.30			3.04
LH1622 - DD3F2					25.4	4.45			2.60
BL822F1 - D2	25.400	24.10	4.60	8.80	32.4	6.80	84.5/19010	93.0	3.03
BL822HF1 - D2				9.53	32.4	3.07			
BL822HF2 - DD3	25.400	24.00	5.00	9.53	35.0	7.05	84.5/19010	97.5	2.55
BL1022F1 - D2	31.750	29.00	5.60	11.30	41.2	8.40	130.0/29245	143.0	4.49
BL1022H - D2	31.750	29.70	5.60	11.10	41.2	8.40	130.0/29245	143.0	4.69
LH2022 - DD3F1	31.750	29.70	4.80	11.10	30.4	5.50	115.6/25987	127.2	3.89
LL1222F3 - D2	19.050	14.50	2.25	5.72	22.0	6.30	44.1/9920	48.5	0.89
LL1222F5 - DD3	19.050	14.50	3.00	5.72	29.0	8.30	45.1/10139	49.5	1.17
LL1222F5 - DD3F1	19.050	14.50	3.00	5.72	22.0	4.80	45.1/10140	50.5	1.10
LL1622 - D2	25.400	21.00	3.10	8.28	36.1	11.70	58.0/13050	64.0	1.92
LL1622F7 - DD3	25.400	21.00	3.05	8.28	35.0	11.20	75.4/16950	79.2	1.85
LL1622F7 - DD3F1	25.400	20.00	3.00	8.28	30.5	9.00	58.0/13040	63.8	1.65
LL1623F1 - DD3	25.400	21.00	4.00	8.28	34.0	7.00	60.0/13488	66.0	2.70
F1422 - DD3	14.290	13.00	2.03	4.97	19.1	5.20	27.5/6182	30.0	0.76
1922V - D2	19.050	16.70	3.17	6.10	22.6	4.65	55.0/12364	60.5	1.40
F2022 - D2	20.750	19.00	3.40	7.65	23.0	4.50	50.0/11500	55.0	1.79
F2422 - D2	23.950	22.20	3.86	8.69	27.8	5.90	60.0/13500	66.0	2.37
F2422F1 - D2	24.000	22.00	4.00	9.00	27.0	5.40	60.0/13500	66.0	2.39

板式链 Leaf chains

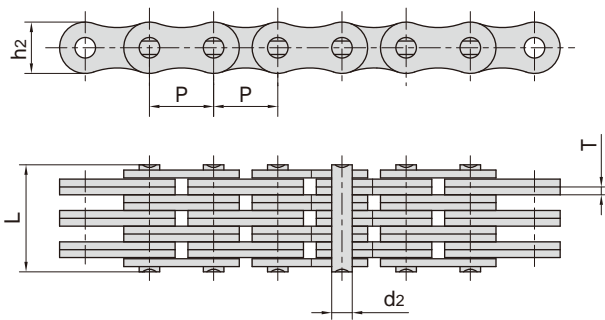

链板组合
Plate lacing

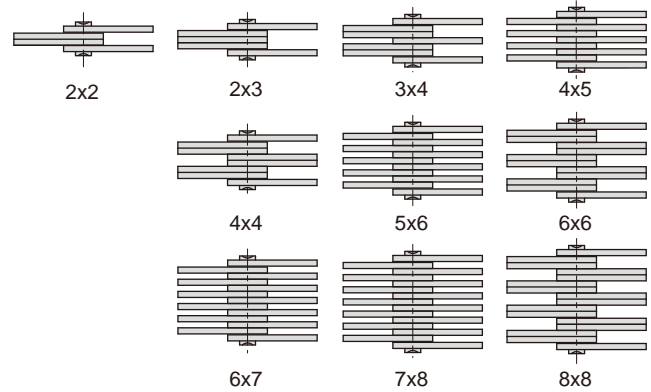

东华链号 Donghua Chain No.	节距	链板组合	链板高度	链板厚度	销轴直径	销轴长度	链条长度(100节)	抗拉强度	每米长重
	Pitch	Plate lacing	Plate depth	Plate thickness	Pin diameter	Pin length	Chain length for 100 pitches (± 0.25%)	Tensile strength	Weight per meter
	P		h2 max	T max	d2 max	L max		Q min	q
	mm		mm	mm	mm	mm	mm	kN/lbf	kg/m
1222	12.700	2 × 2	10.6	1.70	4.45	9.2	1262	21.0/4721	0.44
1234		3 × 4				14.2		31.0/6974	0.75
1244		4 × 4				16.1		42.0/9442	0.86
1256		5 × 6				21.1		53.0/12045	1.17
1266		6 × 6				23.0		63.0/14162	1.27
1288		8 × 8				29.9		85.0/19318	1.70
1523	15.875	2 × 3	12.7	1.94	5.08	12.1	1580	29.0/6590	0.75
1534		3 × 4				16.5		46.0/10454	1.04
1543		4 × 3				16.5		46.0/10455	1.05
1544		4 × 4				18.6		58.0/13181	1.18
1545		4 × 5				20.3		58.0/13181	1.33
1556		5 × 6				24.0		72.0/16363	1.63
1566		6 × 6				26.2		87.0/19772	1.77
1567		6 × 7				28.0		90.0/20454	1.91
1578		7 × 8				32.5		101.0/22954	2.20
1588	8 × 8	34.0	115.0/26136	2.34					
1944	19.050	4 × 4	15.0	2.29	5.72	21.3	1891	73.0/16590	1.58
1966		6 × 6				30.7		110.0/25000	2.37
1978		7 × 8				37.7		122.0/27426	2.98
1988		8 × 8				40.0		140.0/31817	3.13

注：带 表示链板组合特殊
Note: means special link plate combination

板式链 Leaf chains

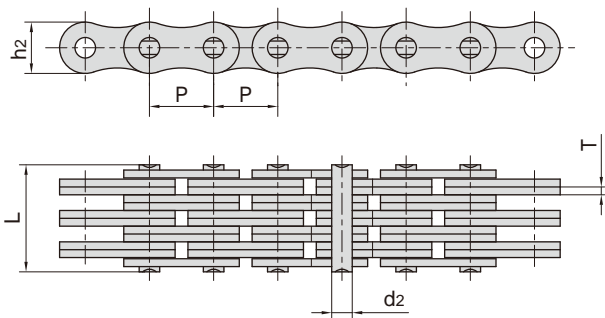

链板组合
Plate lacing

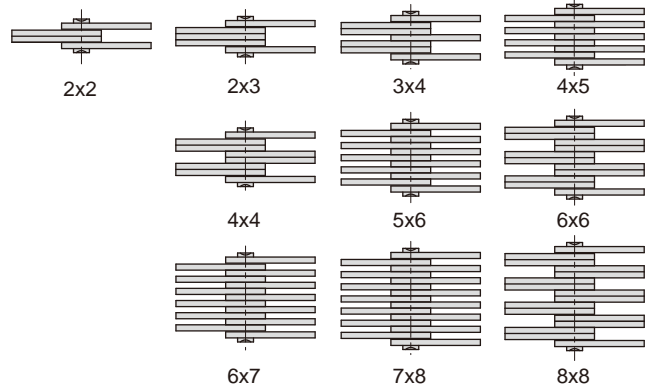

东华链号 Donghua Chain No.	节距	链板组合	链板高度	链板厚度	销轴直径	销轴长度	链条长度(100节)	抗拉强度	每米长重
	Pitch	Plate lacing	Plate depth	Plate thickness	Pin diameter	Pin length	Chain length for 100 pitches ($\pm 0.25\%$)	Tensile strength	Weight per meter
	P		h_2 max	T max	d_2 max	L max		Q min	q
	mm		mm	mm	mm	mm	mm	kN/lbf	kg/m
2522	25.400	2 × 2	20.2	3.06	8.28	15.5	2532	72.0/16186	1.47
2523		2 × 3				18.8		72.0/16363	1.83
2534		3 × 4				25.3		108.0/24545	2.55
2544		4 × 4				29.5		145.0/32597	2.92
2545		4 × 5				31.6		144.0/30727	3.26
2556		5 × 6				38.2		180.0/40908	3.96
2567		6 × 7				43.8		216.0/49090	4.68
2578		7 × 8				50.0		252.0/57272	5.39
2588		8 × 8				52.8		290.0/65908	5.77
3134	31.750	3 × 4	22.8	4.10	10.19	33.3	3168	160.0/35968	4.16
3144		4 × 4				37.5		214.0/48109	4.24
3166		6 × 6				54.3		304.0/68339	6.33
3188		8 × 8				71.1		428.0/96214	8.40
1244F3	12.700	4 × 4	11.0	1.43	4.45	13.9	1262	24.97/7861	0.78
1266F1		6 × 6				19.9		52.46/7861	1.06

空心销轴板式链 Hollow pin leaf chains

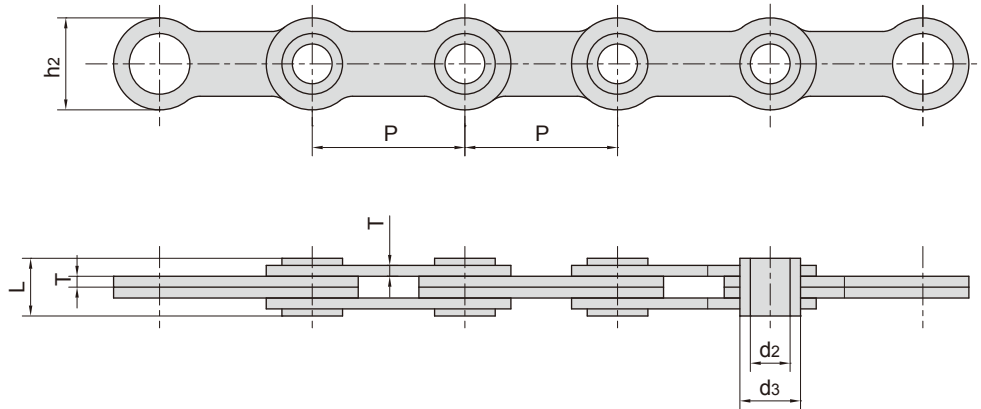

东华链号 Donghua Chain No.	节距 Pitch	链板组合 Plate lacing	链板高度 Plate depth	链板厚度 Plate thickness	销轴直径 Pin diameter		销轴长度 Pin length	抗拉强度 Tensile strength	平均抗拉强度 Average tensile strength	每米长重 Weight per meter
	P		h2 max	T max	d2 min	d3 max	L max	Q min	Q0	q
	mm		mm	mm	mm	mm	mm	kN/lbf	kN	kg/m
LF36	36.513	2 × 2	22.3	2.03	10.2	14.4	12.0	20.0/4496	25.0	0.85
LF36F2	36.513	2 × 2	24.0	2.50	9.5	14.9	15.0	30.0/6744	37.5	1.19
LF36F3	36.513	2 × 2	24.0	2.50	10.0	14.9	15.0	30.0/6744	37.5	1.16
LF36F4	36.513	2 × 2	23.6	2.60	8.2	11.0	16.6	15.0/3372	30.0	1.25
LF36F6	36.513	2 × 2	22.0	2.60	9.5	14.5	14.5	35.0/7868	37.5	1.15
LF36F7	36.513	2 × 2	22.4	2.60	9.6	13.0	14.7	31.0/6969	40.5	1.05
LF36F8	36.513	2 × 2	23.6	2.60	10.0	13.0	16.6	15.0/3372	30.0	1.25

堆高机用板式链 Leaf chains for sky stacker

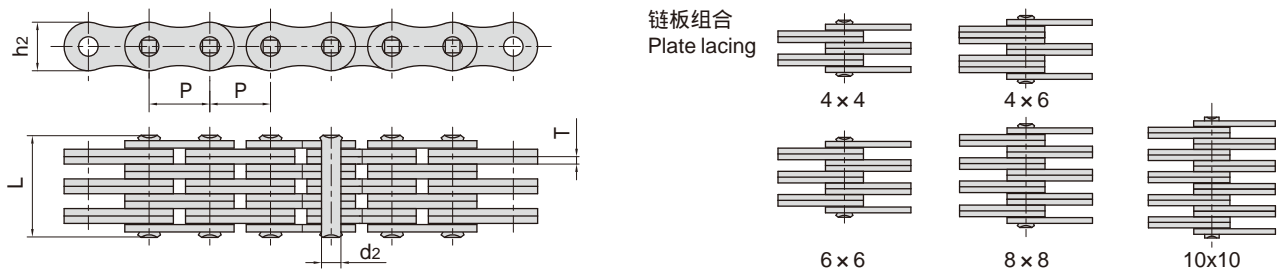

东华链号 Donghua Chain No.	节距	链板组合	链板高度	链板厚度	销轴直径	销轴长度	抗拉强度	平均抗拉强度	每米长重
	Pitch	Plate lacing	Plate depth	Plate thickness	Pin diameter	Pin length	Tensile strength	Average tensile strength	Weight per meter
	P mm		h2 max mm	T max mm	d2 max mm	L max mm	Q min kN/lbf	Q0 kN	q kg/m
LH2044(DG)	31.75	4 × 4	30.18	4.80	11.10	43.8	231.3/51996	254.4	7.60
LH2066(DG)	31.75	6 × 6	30.18	4.80	11.10	64.0	347.0/78008	380.0	11.65
LH2444(DG)	38.10	4 × 4	36.20	5.60	12.70	51.3	302.5/68002	332.8	10.30
LH2466(DG)	38.10	6 × 6	36.20	5.60	12.70	75.5	453.7/101992	475.0	11.52
LH2488(DG)	38.10	8 × 8	36.20	5.60	12.70	96.5	605.0/136004	665.5	21.60
LH2844(DG)	44.45	4 × 4	42.20	6.40	14.27	57.5	382.6/86008	400.0	14.12
LH2846(DG)	44.45	4 × 6	42.20	6.40	14.27	73.0	382.6/86009	400.0	17.63
LH2866(DG)	44.45	6 × 6	42.20	6.40	14.27	83.2	706.0/158709	810.0	21.09
LH3234(DG)	50.80	3 × 4	48.20	7.20	17.46	57.9	440.4/99002	506.0	15.49
LH3244(DG)	50.80	4 × 4	48.20	7.20	17.46	65.1	573.8/128990	602.0	17.67
LH3246(DG)	50.80	4 × 6	48.20	7.20	17.46	80.0	573.8/128990	602.0	22.20
LH3266(DG)	50.80	6 × 6	48.20	7.20	17.46	96.7	867.4/194991	911.0	26.70
LH3288(DG)	50.80	8 × 8	48.20	7.20	17.46	123.3	1156.5/259981	1214.0	35.00
LH4044(DG)	63.50	4 × 4	60.33	9.91	23.81	91.5	867.4/194992	954.1	31.60
LH4066(DG)	63.50	6 × 6	60.33	9.91	23.81	131.2	1301.1/292487	1496.0	48.10
LH2466F2(DG)	38.10	6 × 6	36.20	5.60	12.70	75.5	648.0/145670	710.0	11.52
LH2488F4(DG)	38.10	8 × 8	36.20	5.60	12.70	97.3	800.0/179840	880.0	21.69
LH3266(DGF1)	50.80	6 × 6	48.20	7.20	17.46	94.2	993.6/223361	1143.0	26.35
LH3288(DGF2)	50.80	8 × 8	48.20	7.20	17.46	124.5	1364.6/306774	1500.0	35.09
LH3288F7(DG)	50.80	8 × 8	48.20	7.20	17.46	127	1513.0/340122	1664.3	35.19
BL2088F2(DG)	63.50	8 × 8	58.20	9.70	23.81	170.0	1734.8/389983	1995.0	56.74
LL2466(DG)	38.10	6 × 6	33.40	5.00	14.63	67.4	510.0/114648	536.0	13.00
LL2866(DG)	44.45	6 × 6	36.00	6.00	15.90	80.2	600.0/134880	660.0	16.31
LL4066(DG)	63.50	6 × 6	52.70	8.00	22.89	106.5	1080.0/242793	1245.0	31.62
LL4088(DG)	63.50	8 × 8	52.70	8.00	22.89	140.0	1400.0/314733	1650.0	42.10
LL2844(DGF1)	44.45	4 × 4	36.00	6.00	15.90	54.7	400.0/89923	450.0	10.92
LL2866(DGF1)	44.45	6 × 6	36.00	6.00	15.90	80.2	650.0/146120	715.0	16.20
LL3244F2(DG)	50.80	4 × 4	43.10	6.00	17.76	55.0	520.0/116900	570.0	12.62
LL3244F6(DG)	50.80	4 × 4	42.00	6.00	17.81	57.5	520.0/116900	570.0	12.35
LL3266F6(DG)	50.80	6 × 6	42.00	6.00	17.81	81.7	780.0/175344	858.0	18.30
LL3266(DGF1)	50.80	6 × 6	42.00	6.40	17.81	86.0	780.0/175344	858.0	19.53
LL3266F3(DG)	50.80	6 × 6	43.10	6.00	17.76	79.9	780.0/178344	858.0	18.84
LL3288F6(DG)	50.80	8 × 8	42.00	6.00	17.81	106.0	1040.0/233792	1144.0	24.30
LL3288(DGF2)	50.80	8 × 8	42.00	6.40	17.81	112.0	1040.0/233792	1144.0	25.91
LL4088F2(DG)	63.50	8 × 8	52.70	8.20	22.89	140.0	1440.0/323725	1670.0	42.39

堆高机用板式链 Leaf chains for sky stacker

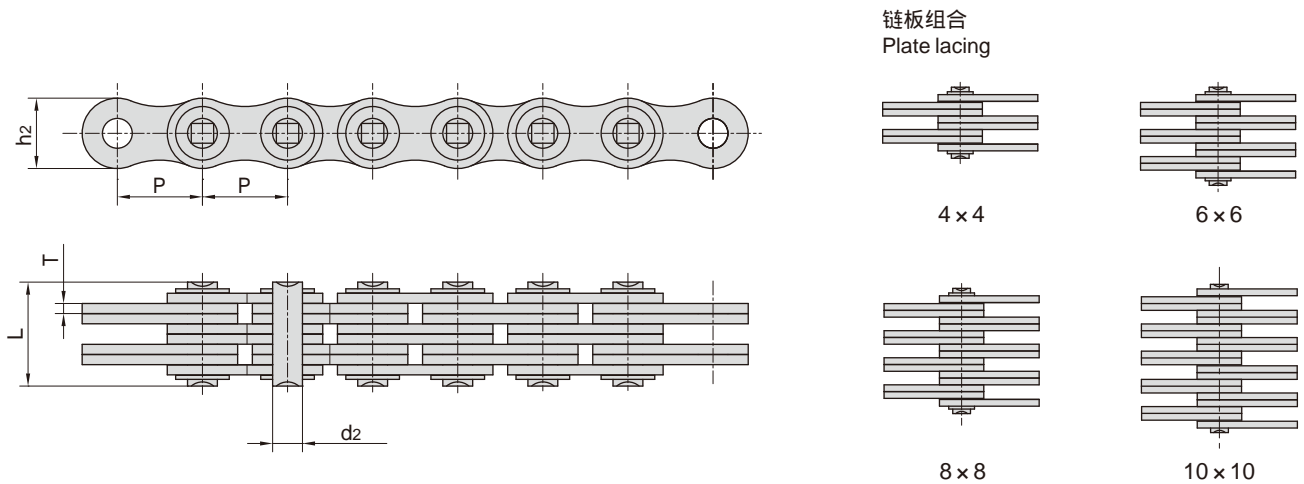

东华链号 Donghua Chain No.	节距	链板组合	链板高度	链板厚度	销轴直径	销轴长度	抗拉强度	平均抗拉强度	每米长重
	Pitch	Plate lacing	Plate depth	Plate thickness	Pin diameter	Pin length	Tensile strength	Average tensile strength	Weight per meter
	P mm		h2 max mm	T max mm	d2 max mm	L max mm	Q min kN/lbf	Q0 kN	q kg/m
LL3244(DG)	50.80	4 × 4	42.00	6.40	17.81	65.0	520.0/116895	598.0	13.73
LL3266(DG)		6 × 6				90.8	780.0/175344	897.0	19.94
LL3288(DG)		8 × 8				117.0	1040.0/233792	1196.0	26.10
LL321010F10(DG)	50.80	10 × 10	42.00	6.00	17.81	134.3	1300.0/292240	1430.0	30.89
LL4066F5(DG)	63.50	6 × 6	52.70	8.00	22.89	112.7	1080.0/242794	1245.0	32.59
LL4088F4(DG)	63.50	8 × 8	52.70	8.00	22.89	144.0	1400.0/314720	1540.0	42.38

LH系列板式链连接环

Clevises for LH series leaf chains

外连接环
Outside clevis

内连接环
Inside clevis

外连接环
Outside clevis

内连接环
Inside clevis

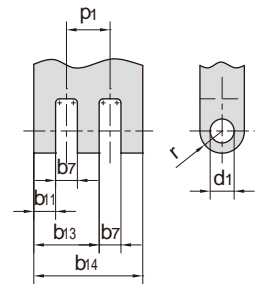
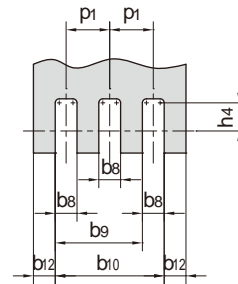
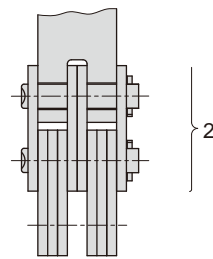
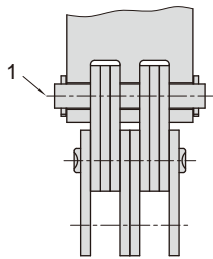

连接环形式
Clevis type

连接环的尺寸代号
Dimension symbols of clevis

ISO 链号 ISO Chain No.	ANSI 链号 ANSI Chain No.	b7	b8	b9	b10	b11 max	b12 min	b13 max	b14 max	p1 nom	d1 min	h4 min	r max
		mm	mm	mm	mm	mm	mm	mm	mm	mm	mm	mm	mm
LH0822	BL422	-	4.41	-	-	4.03	3.12	-	-	-	5.11	6.35	6.35
LH0823	BL423	-	6.53	-	-	6.05	3.12	-	-	-			
LH0834	BL434	2.21	4.33	10.68	-	4.03	3.12	10.20	-	6.35			
LH0844	BL444	4.41	4.41	12.89	-	4.03	3.12	12.25	-	8.47			
LH0846	BL446	4.41	6.53	17.12	-	6.05	3.12	16.32	-	10.59			
LH0866	BL466	4.41	4.41	12.89	21.36	4.03	3.12	12.25	20.47	8.47			
LH1022	BL522	-	5.24	-	-	4.80	3.72	-	-	-	5.98	7.92	7.92
LH1023	BL523	-	7.76	-	-	7.20	3.72	-	-	-			
LH1034	BL534	2.62	5.14	12.69	-	4.80	3.72	12.12	-	7.55			
LH1044	BL544	5.24	5.24	15.31	-	4.80	3.72	14.56	-	10.07			
LH1046	BL546	5.24	7.76	20.35	-	7.20	3.72	19.40	-	12.59			
LH1066	BL566	5.24	5.24	15.31	25.38	4.80	3.72	14.56	24.31	10.07			
LH1222	BL622	-	6.96	-	-	6.41	4.95	-	-	-	7.96	9.53	9.53
LH1223	BL623	-	10.31	-	-	9.61	4.95	-	-	-			
LH1234	BL634	3.48	6.83	16.88	-	6.41	4.95	16.18	-	10.05			
LH1244	BL644	6.96	6.96	20.36	-	6.41	4.95	19.43	-	13.40			
LH1246	BL646	6.96	10.31	27.06	-	9.61	4.95	25.89	-	16.75			
LH1266	BL666	6.96	6.96	20.36	33.76	6.41	4.95	19.43	32.45	13.40			
LH1622	BL822	-	8.59	-	-	7.93	6.13	-	-	-	9.56	12.70	12.70
LH1623	BL823	-	12.73	-	-	11.89	6.13	-	-	-			
LH1634	BL834	4.29	8.43	20.86	-	7.93	6.13	19.97	-	12.42			
LH1644	BL844	8.59	8.59	25.15	-	7.93	6.13	23.98	-	16.56			
LH1646	BL846	8.59	12.73	33.43	-	11.89	6.13	31.96	-	20.70			
LH1666	BL866	8.59	8.59	25.15	41.71	7.93	6.13	23.98	40.04	16.56			

注：1-连接销轴 2-连接链节^a
 Note: 1-connecting pin 2-connecting link^a

a-连接链节应使用具有过盈配合的外链板
 a- the connecting link should be used with a press fit outer plate