

## 短节距输送链附件 Short pitch conveyor chain attachments

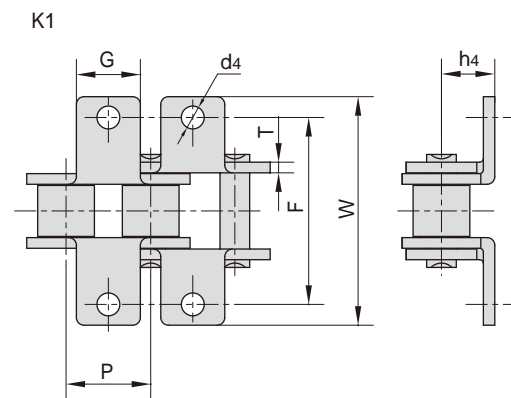
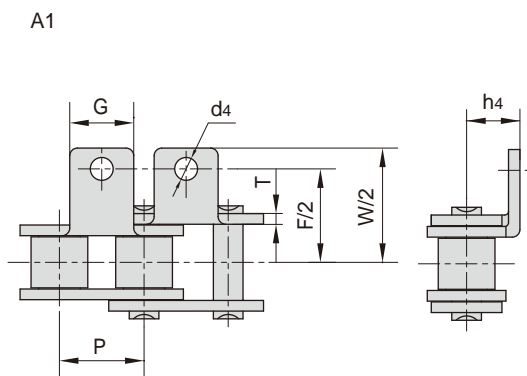

ISO/DIN 链号 ISO/DIN Chain No.	东华 链号 Donghua Chain No.	P	G	F	W	T	h4	d4
		mm	mm	mm	mm	mm	mm	mm
25	04C	6.350	5.6	13.80	23.2	0.80	4.30	3.4
35	06C	9.525	7.9	19.00	28.6	1.30	6.35	3.4
40	08A	12.700	9.5	25.40	35.2	1.50	7.90	3.4
41	085	12.700	9.5	24.00	33.4	1.30	6.90	3.6
50	10A	15.875	12.7	31.75	46.2	2.03	10.30	5.5
60	12A	19.050	15.9	38.10	55.6	2.42	11.90	5.5
80	16A	25.400	19.1	50.80	64.8	3.25	15.90	6.8
100	20A	31.750	25.4	63.50	89.8	4.00	19.80	9.2
120	24A	38.100	28.6	76.20	108.5	4.80	23.00	9.8
140	28A	44.450	34.9	88.90	123.0	5.60	28.60	11.4
160	32A	50.800	38.1	101.60	142.8	6.40	31.75	13.1
200	40A	63.500	50.8	127.00	179.0	8.00	42.88	16.3
*06B	*06B	9.525	8.0	19.04	27.0	1.30	6.50	3.5
08B	08B	12.700	9.5	25.40	36.4	1.60	8.90	4.5
10B	10B	15.875	14.3	31.75	44.6	1.70	10.31	5.3
12B	12B	19.050	16.0	38.10	52.4	1.85	13.46	6.4
16B	16B	25.400	19.1	50.80	72.6	3.10	15.88	6.4
20B	20B	31.750	35.0	63.50	100.5	3.50	19.80	9.0
24B	24B	38.100	30.0	76.20	108.4	4.80	26.67	10.5
28B	28B	44.450	35.0	88.90	123.0	6.00	28.58	13.1
32B	32B	50.800	38.1	101.60	142.8	6.00	31.75	13.1

\*直链板  
\*Straight side plates

## 短节距输送链附件 Short pitch conveyor chain attachments



SA1/M1单侧(one side)

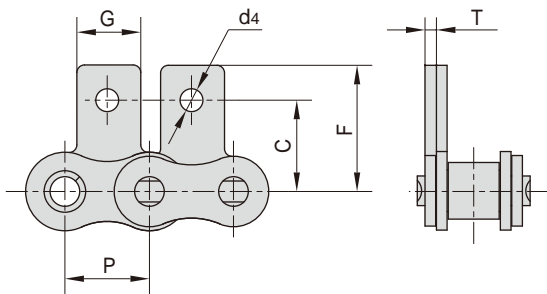

SK1/M1双侧(both sides)

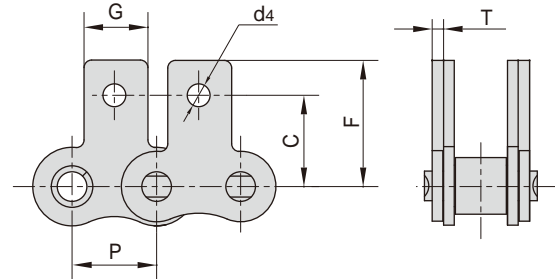

ISO/DIN 链号 ISO/DIN Chain No.	东华 链号 Donghua Chain No.	P	G	C	F	T	d4
		mm	mm	mm	mm	mm	mm
25	04C	6.350	5.6	7.95	11.70	0.80	3.4
35	06C	9.525	7.9	9.50	14.55	1.30	3.4
40	08A	12.700	9.5	12.70	19.05	1.50	3.4
41	085	12.700	9.5	11.85	16.55	1.30	3.6
50	10A	15.875	12.7	15.90	25.25	2.03	5.5
60	12A	19.050	15.9	18.30	29.33	2.42	5.5
80	16A	25.400	19.1	24.60	34.70	3.25	6.8
100	20A	31.750	25.4	31.80	43.30	4.00	9.2
120	24A	38.100	28.6	36.50	51.60	4.80	9.8
140	28A	44.450	34.9	44.50	62.00	5.60	11.4
160	32A	50.800	38.1	50.80	69.85	6.40	13.1
200	40A	63.500	50.8	63.50	88.90	8.00	16.3
*06B	*06B	9.525	8.0	9.52	13.50	1.30	3.5
08B	08B	12.700	9.5	13.35	18.90	1.60	4.3
10B	10B	15.875	14.3	16.50	22.95	1.70	5.3
12B	12B	19.050	16.0	21.45	28.60	1.85	6.4
16B	16B	25.400	19.1	23.15	34.00	3.10	6.4
20B	20B	31.750	35.0	30.50	45.70	3.50	9.0
24B	24B	38.100	36.0	36.00	61.50	4.80	10.5

\*直链板  
\*Straight side plates

## 短节距输送链附件 Short pitch conveyor chain attachments

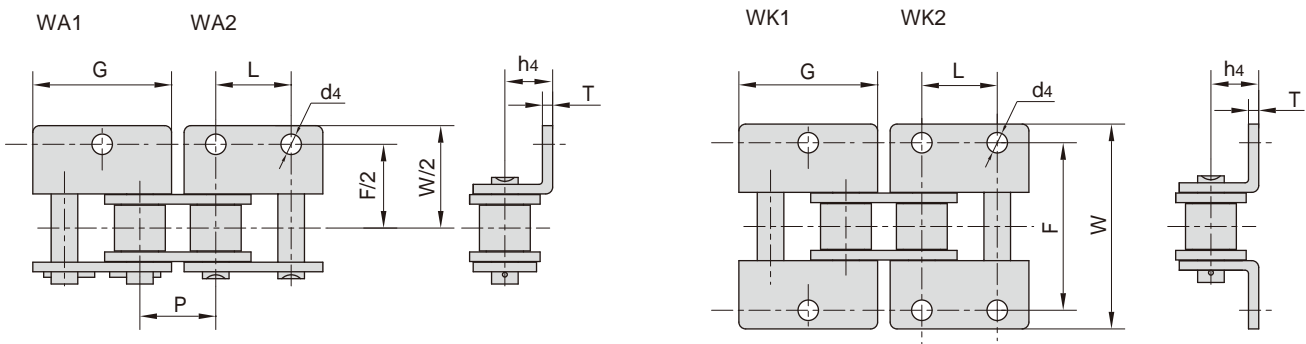

ISO/DIN 链号 ISO/DIN Chain No.	东华 链号 Donghua Chain No.	P	G	L	F	W	T	h4	d4
		mm	mm	mm	mm	mm	mm	mm	mm
25	04C	6.350	11.41	6.350	13.80	23.2	0.80	4.30	3.40
35	06C	9.525	17.32	9.525	19.00	28.6	1.30	6.35	2.80
40	08A	12.700	23.00	12.700	25.40	35.6	1.50	7.90	3.40
41	085	12.700	22.30	12.700	24.00	35.0	1.30	7.20	4.85
50	10A	15.875	28.80	15.875	31.75	46.8	2.03	10.30	5.50
60	12A	19.050	34.65	19.050	38.10	56.4	2.42	11.90	5.50
80	16A	25.400	45.90	25.400	50.80	73.2	3.25	15.90	6.80
100	20A	31.750	57.65	31.750	63.50	89.8	4.00	19.80	9.20
120	24A	38.100	69.30	38.100	76.20	108.8	4.80	23.00	9.80
140	28A	44.450	80.45	44.450	88.90	123.0	5.60	28.60	11.40
160	32A	50.800	92.00	50.800	101.60	142.8	6.40	31.75	13.10
200	40A	63.500	115.50	63.500	127.00	179.0	8.00	42.88	16.30
*06B	*06B	9.525	17.72	9.525	19.04	27.0	1.30	6.50	3.50
08B	08B	12.700	24.00	12.700	25.40	36.4	1.60	8.90	4.30
10B	10B	15.875	29.58	15.875	31.80	44.6	1.70	10.31	5.30
12B	12B	19.050	34.05	19.050	38.10	52.4	1.85	13.46	6.40
16B	16B	25.400	46.40	25.400	50.80	72.6	3.10	15.88	6.40
20B	20B	31.750	58.10	31.750	63.50	100.5	3.50	19.80	9.00
24B	24B	38.100	71.30	38.100	76.20	108.4	4.80	26.67	10.50
28B	28B	44.450	81.10	44.450	88.90	123.0	6.00	28.58	13.10
32B	32B	50.800	92.80	50.800	101.60	142.8	6.00	31.75	13.10

\*直链板  
\*Straight side plates

## 短节距输送链附件 Short pitch conveyor chain attachments

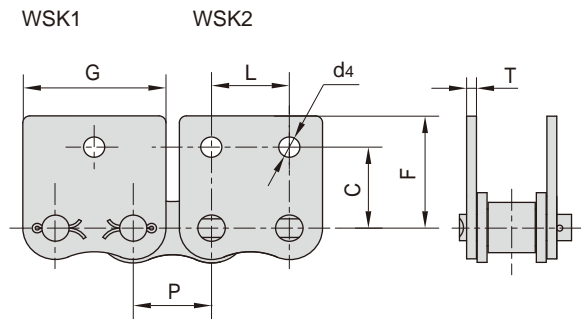
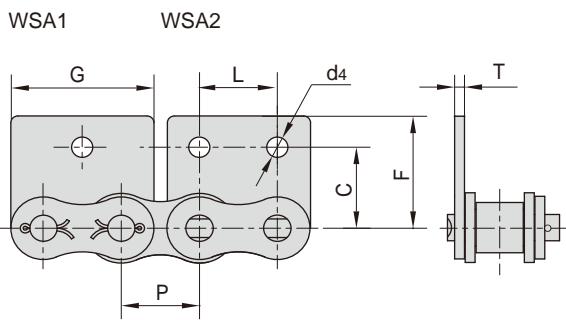

ISO/DIN 链号 ISO/DIN Chain No.	东华 链号 Donghua Chain No.	P	G	L	C	F	T	d4
		mm	mm	mm	mm	mm	mm	mm
25	04C	6.350	11.41	6.350	7.95	11.70	0.80	3.4
35	06C	9.525	17.32	9.525	9.50	14.55	1.30	2.8
40	08A	12.700	23.00	12.700	12.70	17.40	1.50	3.4
41	085	12.700	21.20	12.700	11.85	16.55	1.30	3.6
50	10A	15.875	28.80	15.875	15.90	23.05	2.03	5.5
60	12A	19.050	34.65	19.050	18.30	26.86	2.42	5.5
80	16A	25.400	45.90	25.400	24.60	35.45	3.25	6.8
100	20A	31.750	57.65	31.750	31.80	44.00	4.00	9.2
120	24A	38.100	69.30	38.100	36.50	51.60	4.80	9.8
140	28A	44.450	80.45	44.450	44.50	62.00	5.60	11.4
160	32A	50.800	92.00	50.800	50.80	69.85	6.40	13.1
200	40A	63.500	115.5	63.500	63.50	88.90	8.00	16.3
*06B	*06B	9.525	17.72	9.525	9.52	13.50	1.30	3.5
08B	08B	12.700	23.30	12.700	13.35	18.90	1.60	4.3
10B	10B	15.875	29.58	15.875	16.50	22.95	1.70	5.3
12B	12B	19.050	34.05	19.050	21.45	28.60	1.85	6.4
16B	16B	25.400	46.40	25.400	23.15	34.00	3.10	6.4
20B	20B	31.750	58.10	31.750	30.50	45.70	3.50	9.0
24B	24B	38.100	71.30	38.100	42.70	61.50	4.80	10.5

\*直链板  
\*Straight side plates

## 短节距输送链附件

### Short pitch conveyor chain attachments



东华链号 Donghua Chain No.	P	G	F	W	T	h4	d4
	mm	mm	mm	mm	mm	mm	mm
04CA1F2	6.350	6.00	22.20	29.00	0.80	2.50	2.00
25K1F1	6.350	5.60	14.27	21.38	0.80	4.75	3.40
05BA1F1	8.000	8.00	14.00	21.00	0.80	5.00	3.10
*06BK1F3	9.525	8.00	18.81	26.81	1.15	6.50	3.50
*06BK1F5	9.525	8.00	19.04	27.04	1.30	6.50	4.50
*06BK1F6	9.525	8.00	29.08	41.68	1.30	8.90	4.50
06CA1F1	9.525	7.90	19.20	28.80	1.30	6.35	2.80
06CA1F2	9.525	7.90	19.20	28.80	1.30	6.35	4.00
*C40A1F1	12.700	10.00	25.40	33.40	1.50	9.10	3.40
08AA1F1	12.700	9.50	38.50	44.50	1.50	8.20	3.60
08AA1F10	12.700	9.60	28.00	36.20	1.50	8.50	3.20
08AA1F12	12.700	9.50	25.40	35.20	1.50	7.90	3.20
08AA1F14	12.700	10.80	26.40	35.40	1.50	9.00	4.40
08AA1F15	12.700	18.00	26.40	39.00	1.50	9.00	4.20
08AA1F18	12.700	11.00	36.85	46.00	1.50	7.90	3.60
08AA1F2	12.700	9.50	25.40	35.20	1.50	7.90	4.85
08AA1F3	12.700	15.88	25.40	35.60	1.50	8.00	4.95
08AA1F6	12.700	9.50	25.40	35.20	1.50	7.90	5.00
08AA1F7	12.700	18.00	37.00	52.00	1.50	8.00	5.20
08AA1F9	12.700	9.60	55.40	62.50	1.50	7.50	4.20
08AK1F16	12.700	10.50	25.40	38.80	1.50	7.95	5.50
08AK1F2	12.700	9.50	25.40	35.20	1.50	7.90	4.85
08AK1F4	12.700	9.50	25.39	35.19	1.50	7.90	5.50
08BA1F11	12.700	11.00	25.40	36.40	1.60	8.90	4.30
08BA1F16	12.700	12.30	27.80	42.80	1.60	21.00	5.20
08BA1F18	12.700	9.50	28.30	37.00	1.60	8.00	4.30
08BA1F2	12.700	11.40	38.60	49.60	1.60	8.90	3.50
08BA1F20	12.700	12.60	22.95	33.95	1.60	10.20	5.00
08BA1F28	12.700	9.50	25.40	34.52	1.60	9.95	4.00
08BA1F30	12.700	11.00	26.23	35.43	1.60	9.00	4.50
08BA1F33	12.700	10.00	30.40	38.80	1.60	8.20	3.10
08BA1F34	12.700	9.60	36.40	48.00	1.60	9.60	3.20

\*直链板

\*Straight side plates

## 短节距输送链附件 Short pitch conveyor chain attachments



东华链号 Donghua Chain No.	P mm	G mm	F mm	W mm	T mm	h4 mm	d4 mm
08BA1F39	12.700	9.50	36.40	44.00	1.60	9.50	3.20
08BA1F40	12.700	9.50	26.60	34.20	1.60	8.50	3.20
08BA1F41	12.700	12.50	35.00	43.00	1.60	9.00	3.70
08BA1F47	12.700	9.50	26.60	32.60	1.60	8.50	3.10
08BA1F48	12.700	13.00	38.20	48.60	1.60	10.50	6.10
08BA1F49	12.700	12.00	26.00	38.80	1.60	8.00	3.50
08BA1F51	12.700	9.50	25.40	35.20	1.60	8.90	4.30
08BA1F53	12.700	11.00	26.00	36.40	1.60	8.90	6.5 × 4.5
08BA1F56	12.700	9.50	34.20	43.70	1.60	9.00	3.10
08BA1F58	12.700	9.50	47.00	57.50	1.60	8.90	4.50
08BA1F6	12.700	18.00	25.80	37.80	1.60	8.00	4.20
08BA1F8	12.700	11.20	21.85	32.85	2.50	8.90	4.30
08BA3F1	12.700	22.70	33.20	46.90	1.60	7.80	2.9/6.7
08BF30	12.700	18.00	27.20	40.00	1.60	8.00	4.30
08BF33	12.700	9.50	27.74	38.80	1.60	8.50	3.10
08BK1F10	12.700	11.00	27.77	38.77	1.55	8.75	4.30
08BK1F14	12.700	11.00	25.57	36.57	1.60	8.90	6.50
08BK1F15	12.700	17.90	27.60	39.60	1.60	8.00	7.10
08BK1F26	12.700	11.00	26.50	36.00	1.60	8.80	4.40
08BK1F29	12.700	12.50	26.20	38.00	1.60	10.00	4.50
08BK1F35	12.700	9.50	25.33	35.03	1.60	8.90	M3
08BK1F43	12.700	9.50	28.20	37.20	1.60	8.40	4.30
08BK1F44	12.700	11.50	26.00	36.00	1.60	8.50	4.20
08BK1F5	12.700	9.50	29.00	38.70	1.60	7.10	4.50
08BK1F54	12.700	14.00	30.20	42.00	1.60	8.90	5.50
08BK1F55	12.700	12.00	25.40	36.40	1.60	8.90	5.00
08BK1F57	12.700	12.00	25.40	36.40	1.60	8.90	5.50
08BK1F7	12.700	9.50	29.00	39.00	1.60	7.00	4.50
08BK1F9	12.700	9.50	25.40	36.40	1.60	8.90	M4
428HK1F3	12.700	11.50	30.00	43.50	2.03	8.90	5.50
*C10BK0F1	15.875	13.00	-	35.00	1.70	10.30	-
10AA1F10	15.875	12.70	31.80	46.20	2.03	10.30	M5
10AA1F11	15.875	12.70	31.80	46.20	2.03	25.30	5.50

\*直链板  
\*Straight side plates

## 短节距输送链附件

### Short pitch conveyor chain attachments



东华链号 Donghua Chain No.	P mm	G mm	F mm	W mm	T mm	h4 mm	d4 mm
10AA1F13	15.875	14.00	33.20	50.40	2.03	11.50	3.10
10AA2F1	15.875	24.10	33.60	43.20	2.03	8.20	3.50
10AHK1F1	15.875	12.70	34.00	48.40	2.42	10.30	M5
10AHK1F2	15.875	12.70	33.00	47.40	2.42	10.40	M5
10AK1F23	15.875	20.00	32.16	48.06	2.03	10.90	6.50
10AK1F24	15.875	12.70	31.75	46.20	2.03	10.30	5.20
10AK1F3	15.875	14.29	31.75	46.20	2.03	10.30	5.50
10AK1F5	15.875	20.00	39.00	50.10	2.03	12.50	M5
10AK1F7	15.875	12.70	31.80	46.20	2.03	10.30	M6
10AK1F8	15.875	12.70	31.80	46.20	2.03	10.30	6.50
10AK1F9	15.875	20.00	38.97	50.07	2.03	12.50	5.50
10BA0F2	15.875	14.00	-	49.41	1.70	10.30	-
10BA0F3	15.875	14.00	-	46.51	1.70	10.40	-
10BA1F11	15.875	15.00	31.80	49.60	1.70	10.30	M5
10BA1F13	15.875	14.10	30.81	48.01	1.70	10.50	M5
10BA1F14	15.875	14.30	31.76	44.60	1.70	10.31	6.40
10BF11	15.875	14.00	-	51.81	1.70	10.40	-
10BK0F4	15.875	14.00	-	45.81	1.70	10.30	-
10BK0F5	15.875	15.00	-	69.20	1.70	10.31	-
10BK1F12	15.875	13.00	32.41	50.11	1.70	11.00	6.00
10BK1F17	15.875	14.30	31.80	44.60	1.70	10.31	7.3 × 5.5
10BK1F18	15.875	14.00	32.78	49.96	1.70	11.50	3.10
10BK1F19	15.875	12.80	32.00	46.60	1.70	10.60	M6
10BK1F2	15.875	13.00	32.40	45.20	1.70	11.00	6.00
10BK1F21	15.875	14.00	35.00	50.80	1.70	9.00	7.10
10BK1F22	15.875	14.10	31.80	47.60	1.70	10.40	5.20
10BK1F3	15.875	13.00	32.41	51.11	1.70	10.50	6.00
10BK1F4	15.875	17.50	30.41	47.41	1.70	11.50	6.00
10BK1F5	15.875	13.00	29.41	42.21	1.70	10.00	5.50
10BK1F6	15.875	12.70	30.00	47.00	1.70	10.20	5.30
10BK1F7	15.875	14.00	31.50	49.60	1.70	10.30	5.50
10BK1F8	15.875	14.00	31.41	48.31	1.70	10.50	5.30
10BSBA1F2	15.875	13.50	30.00	44.40	1.70	10.50	5.30

## 短节距输送链附件

### Short pitch conveyor chain attachments



东华链号 Donghua Chain No.	P mm	G mm	F mm	W mm	T mm	h4 mm	d4 mm
50 ORA1F14	15.875	12.70	34.40	48.80	2.03	10.30	5.20
*C12BA1F26	19.050	16.00	37.60	56.00	1.85	13.50	7.20
12AA1F10	19.050	15.90	38.10	55.60	2.42	11.90	7.00
12AA1F32	19.050	25.00	44.84	58.84	2.42	21.00	5.50
12AA1F33	19.050	15.90	38.10	55.60	2.42	11.90	6.30
12AA1F7	19.050	15.90	38.10	55.50	2.42	11.90	6.00
12AA2F11	19.050	21.00	40.00	51.20	2.42	11.90	5.30
12AK1F1	19.050	15.90	40.00	55.60	2.42	11.90	6.20
12AK1F22	19.050	15.90	38.10	55.50	2.42	13.46	M5
12AK1F27	19.050	15.90	60.80	78.20	2.42	11.90	6.35
12AK1F28	19.050	15.90	38.10	55.60	2.42	11.90	8.50
12AK1F30	19.050	15.90	38.20	55.60	2.42	11.90	6.50
12AK1F31	19.050	25.00	45.50	64.50	2.42	11.90	8.20
12AK1F34	19.050	15.90	38.10	55.60	2.42	11.90	M6
12AK1F36	19.050	15.90	38.10	55.60	2.42	11.90	M4
12AK1F4	19.050	15.90	38.10	55.50	2.42	11.90	M5
12AK1F7	19.050	15.90	38.10	55.60	2.42	11.90	6.00
12AK1F8	19.050	15.90	40.00	55.60	2.42	11.90	6.80
12BA0F1	19.050	36.10	-	56.75	1.85	12.00	-
12BA0F3	19.050	33.60	-	56.80	1.85	11.50	-
12BA1F1	19.050	16.00	38.10	52.40	1.85	13.46	8.20
12BA1F12	19.050	18.00	35.20	52.70	1.85	12.20	6.40
12BA1F18	19.050	24.00	35.45	51.75	1.85	12.00	6.60
12BA1F23	19.050	18.00	36.00	56.60	1.85	11.00	M6
12BA1F30	19.050	20.00	45.70	65.60	1.80	12.00	6.40
12BA1F34	19.050	15.90	34.25	55.60	1.85	11.90	10.9 × 6.4
12BFK1	19.050	16.50	40.00	54.80	1.85	12.00	6.60
12BK1F10	19.050	20.50	40.00	54.50	1.85	12.00	8.50
12BK1F11	19.050	16.00	38.15	52.55	1.85	13.46	10.00
12BK1F13	19.050	16.00	40.00	60.00	2.03	11.90	6.50
12BK1F15	19.050	18.00	37.00	54.60	1.85	12.20	6.40
12BK1F17	19.050	16.00	35.64	55.24	1.85	11.90	6.70
12BK1F19	19.050	18.00	36.00	55.40	1.85	12.00	6.60
12BK1F2	19.050	16.00	38.10	52.40	1.85	13.46	8.00

\*直链板

\*Straight side plates



## 短节距输送链附件

### Short pitch conveyor chain attachments

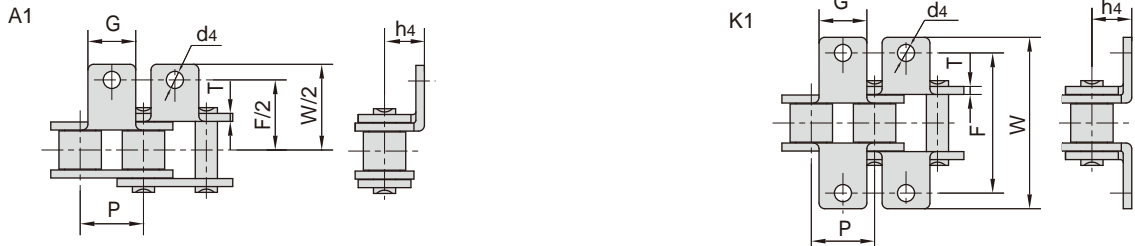

东华链号 Donghua Chain No.	P mm	G mm	F mm	W mm	T mm	h4 mm	d4 mm
12BK1F20	19.050	16.00	35.20	51.40	1.85	12.00	7.60
12BK1F24	19.050	18.50	37.20	58.00	1.85	11.00	M6
12BK1F27	19.050	16.00	28.00	37.60	1.85	12.20	5.00
12BK1F28	19.050	16.00	41.00	54.65	1.85	10.00	6.40
12BK1F29	19.050	16.00	40.00	54.40	1.85	13.40	6.30
12BK1F31	19.050	20.00	44.80	64.80	1.85	11.70	6.50
12BK1F32	19.050	18.00	35.80	55.50	1.85	12.00	10.00
12BK1F33	19.050	16.00	38.10	52.40	1.85	13.46	8.10
12BK1F37	19.050	16.00	28.00	42.00	1.85	13.00	4.50
12BK1F38	19.050	16.00	38.10	52.44	1.85	13.46	7.20
12BK1F4	19.050	16.00	38.10	52.40	1.85	13.46	6.40
12BK1F40	19.050	18.00	35.44	54.94	1.80	11.60	6.40
12BK1F41	19.050	16.00	35.00	51.60	1.85	12.00	5.60
12BK1F5	19.050	18.00	35.44	54.05	1.80	11.60	6.40
12BK1F6	19.050	16.00	35.00	52.40	1.85	13.46	6.40
12BK1F8	19.050	18.00	35.20	50.40	1.85	12.20	6.40
12BK1F9	19.050	16.00	24.80	39.00	1.85	13.46	6.40
*C16BK1F40	25.400	16.00	37.60	56.00	1.85	13.50	7.20
16AA1F12	25.400	19.10	44.00	64.80	3.25	15.90	6.00
16AA1F19	25.400	24.00	50.80	72.80	3.25	15.90	9.00
16AA1F36	25.400	19.10	50.80	64.80	3.25	15.90	8.00
16AA1F4	25.400	19.10	50.80	64.80	3.25	15.90	6.00
16AA1F43	25.400	19.10	50.80	64.80	3.25	15.90	8.20
16AHA1F1	25.400	36.50	52.80	85.80	4.00	15.90	8.90
16AHK1F10	25.400	29.00	50.80	70.60	4.00	19.10	8.20
16AHK1F11	25.400	29.00	58.00	82.60	4.00	16.90	8.10
16AHK1F12	25.400	19.10	50.80	70.60	4.00	19.10	8.50
16AK1F10	25.400	19.10	50.80	64.80	3.25	15.90	10.00
16AK1F14	25.400	19.10	50.71	64.71	3.25	15.90	7.00
16AK1F17	25.400	19.10	50.80	78.60	3.25	15.90	6.80
16AK1F2	25.400	38.10	50.71	73.11	3.25	15.90	7.00
16AK1F3	25.400	30.00	56.30	82.40	3.25	16.00	6.50

\*直链板

\*Straight side plates

## 短节距输送链附件

### Short pitch conveyor chain attachments



东华链号 Donghua Chain No.	P mm	G mm	F mm	W mm	T mm	h4 mm	d4 mm
16AK1F39	25.400	19.10	50.80	64.80	3.25	15.90	5.00
16AK1F40	25.400	19.10	50.80	64.80	3.25	15.90	8.60
16AK1F42	25.400	19.10	50.80	73.20	3.25	15.90	6.80
16AK1F5	25.400	25.40	44.00	56.00	3.25	15.90	6.00
16AK1F6	25.400	24.00	44.00	56.00	3.25	15.90	6.00
16AK1F8	25.400	25.00	57.80	74.90	3.25	14.50	6.80
16BA1F51	25.400	24.00	57.60	82.60	3.10	17.00	9.00
16BA1F7	25.400	24.00	58.00	75.60	3.10	18.00	9.00
16BK1F10	25.400	24.00	53.58	77.58	3.00	16.30	8.20
16BK1F11	25.400	26.00	58.00	74.60	4.00	18.00	9.00
16BK1F13	25.400	25.00	58.00	84.40	3.10	18.00	9.00
16BK1F15	25.400	25.00	68.00	130.00	3.10	17.00	9.10
16BK1F16	25.400	23.80	58.00	83.80	1.85	17.00	8.40
16BK1F17	25.400	25.00	50.80	70.20	4.15	20.20	9.10
16BK1F19	25.400	24.00	57.15	75.00	4.15	18.00	9.00
16BK1F22	25.400	18.00	54.60	72.00	3.10	18.00	10.00
16BK1F28	25.400	25.00	57.80	83.60	3.10	18.00	9.00
16BK1F3	25.400	19.10	50.80	72.60	3.10	15.88	8.20
16BK1F34	25.400	25.40	50.80	72.10	3.10	15.88	M6
16BK1F4	25.400	36.00	54.00	78.60	3.10	16.00	8.20
16BK1F41	25.400	24.00	57.62	75.62	3.10	20.20	8.40
16BK1F42	25.400	24.00	57.72	75.72	3.10	16.50	9.00
16BK1F43	25.400	24.00	58.00	75.60	3.10	18.00	10.00
16BK1F44	25.400	25.00	58.00	84.40	3.10	18.00	10.20
16BK1F45	25.400	23.80	58.00	83.82	3.10	17.00	8.00
16BK1F46	25.400	36.00	54.00	78.60	3.10	16.00	8.40
16BK1F47	25.400	36.00	54.00	78.60	3.10	16.00	10.00
16BK1F48	25.400	19.05	54.43	72.80	3.10	16.00	12.6 × 9.0
16BK1F49	25.400	19.10	50.80	72.60	4.15	15.88	8.20
16BK1F5	25.400	25.00	57.80	83.60	3.10	19.00	9.00
16BK1F52	25.400	40.00	59.58	83.00	3.10	16.85	8.60
16BK1F53	25.400	24.00	58.00	79.60	3.10	18.00	9.00
16BK1F54	25.400	25.00	62.12	88.32	3.10	18.00	9.00
16BK1F56	25.400	19.00	50.80	74.80	3.10	15.90	6.80
20AHK1F1	31.750	25.40	61.08	87.675	4.80	19.81	10.30
20AK1F2	31.750	25.40	53.25	77.15	6.00	19.84	8.20

## 短节距输送链附件 Short pitch conveyor chain attachments



东华链号 Donghua Chain No.	P mm	G mm	F mm	W mm	T mm	h4 mm	d4 mm
20AK1F3	31.750	25.40	63.50	87.30	4.00	19.80	8.70
20AK1F4	31.750	25.40	63.50	89.80	4.00	19.80	8.20
20AK1F5	31.750	26.00	68.00	88.00	4.00	23.50	11.0 × 8.6
20AK1F7	31.750	25.40	63.50	89.60	4.00	19.80	9.20
20AK1F9	31.750	25.40	63.50	89.60	4.00	19.80	10.50
20BA1F6	31.750	35.00	63.50	100.50	3.50	19.80	11.00
20BA2F7	31.750	58.10	63.40	100.40	3.50	19.80	10.50
20BK1F2	31.750	26.00	68.00	88.00	4.50	23.50	9.60
20BK1F4	31.750	25.40	63.50	100.50	3.50	19.80	9.00
20BK1F5	31.750	35.00	65.00	94.20	3.50	19.80	12.50
20BK1F7	31.750	35.00	70.00	100.50	3.50	22.00	8.50
20BK1F8	31.750	35.00	67.00	104.00	3.50	18.00	9.00
*C24BK0F1	38.100	30.00	-	118.00	6.00	25.00	-
*C24BK1F1	38.100	30.00	77.00	108.40	6.00	25.00	10.50
24AA1F1	38.100	28.60	76.20	111.60	4.80	23.80	9.80
24AA1F10	38.100	38.00	88.20	128.00	4.80	27.40	10.50
24AA1F12	38.100	28.40	75.40	99.60	4.80	23.00	10.30
24AA1F14	38.100	28.60	76.20	108.50	4.80	23.00	10.30
24AA1F3	38.100	45.00	110.00	138.00	10.00	30.00	14.00
24AK1F11	38.100	28.60	76.20	108.50	4.80	23.00	M4
24AK1F4	38.100	28.60	88.90	108.80	4.80	23.00	12.00
24AK1F6	38.100	45.00	100.00	128.00	8.00	30.00	12.00
24AK1F7	38.100	30.00	77.00	101.60	4.80	30.00	11.00
24BK1F2	38.100	38.00	88.00	128.00	4.80	25.00	11.00
28AK1F6	44.450	35.50	88.90	107.70	5.60	28.60	11.40
28BF5	44.450	55.00	120.00	148.00	10.00	30.00	14.00
28BF6	44.450	55.00	120.00	154.00	10.00	30.00	20 × 14
28BK1F2	44.450	55.00	120.00	148.00	10.00	30.00	14.00
28BK1F3	44.450	74.00	108.00	155.00	6.00	32.00	13.00
28BK1F4	44.450	35.00	107.00	158.00	6.00	32.00	14.00
32AK1F1	50.800	38.10	101.60	142.80	6.40	31.75	14.30
32BK1F1	50.800	50.80	108.00	152.60	6.00	35.00	14.00
36AK1F1	57.150	40.00	114.30	144.30	7.20	42.00	15.00
40BK1F1	63.500	40.00	140.00	173.40	8.00	48.825	13.00

\*直链板  
\*Straight side plates

## 短节距输送链附件

### Short pitch conveyor chain attachments

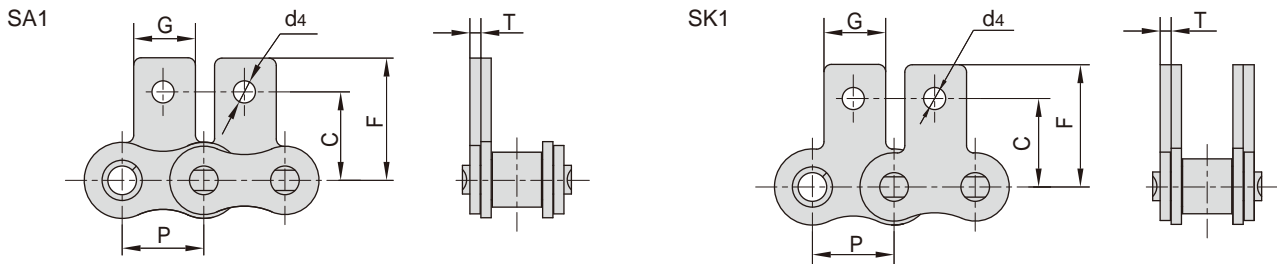

东华链号 Donghua Chain No.	P	G	C	F	T	d4
	mm	mm	mm	mm	mm	mm
05BSA1F1	8.000	8.00	8.00	11.50	0.80	3.10
05BSK1F2	8.000	8.00	7.50	11.50	0.80	3.00
*06BSA0F2	9.525	8.00	-	22.10	1.30	-
*06BSK1F2	9.525	8.00	9.50	13.50	1.15	3.50
06CSA0	9.525	17.32	-	14.55	1.30	-
35SK1F1	9.525	7.90	9.50	14.55	1.30	4.00
*C08BSA1F21	12.700	9.50	13.35	18.90	1.60	5.30
08ASA1F2	12.700	9.50	8.73	17.50	1.50	4.76
08ASA1F3	12.700	9.60	12.70	17.30	1.50	3.60
08ASA1F4	12.700	9.50	12.70	19.05	1.50	4.20
08ASK0F1	12.700	9.50	-	22.23	1.50	-
08BA1F52	12.700	9.50	-	15.00	1.60	-
08BHSK1F1	12.700	11.00	13.35	18.90	2.03	6.50
08BSA0F1	12.700	11.00	-	19.00	1.60	-
08BSA1F1	12.700	18.00	15.00	21.50	1.60	6.30
08BSA1F19	12.700	18.00	15.00	21.50	1.60	8.00
08BSA1F32	12.700	11.00	14.30	20.00	1.60	6.35
08BSA1F8	12.700	12.50	14.70	20.30	1.60	4.50
08BSA1F9	12.700	12.50	14.70	20.30	1.60	4.50
08BSK0F4	12.700	11.00	-	45.00	1.60	-
08BSK0F7	12.700	10.00	-	23.80	1.60	-
08BSK1F12	12.700	12.50	14.70	20.30	1.60	5.00
08BSK1F2	12.700	11.00	13.40	18.90	1.60	4.30
08BSK1F22	12.700	11.00	13.00	20.80	1.60	4.45
08BSK1F3	12.700	11.00	14.10	19.50	1.55	4.30
08BSK1F34	12.700	9.50	14.10	19.20	1.60	4.30

\*直链板

\*Straight side plates

## 短节距输送链附件

### Short pitch conveyor chain attachments

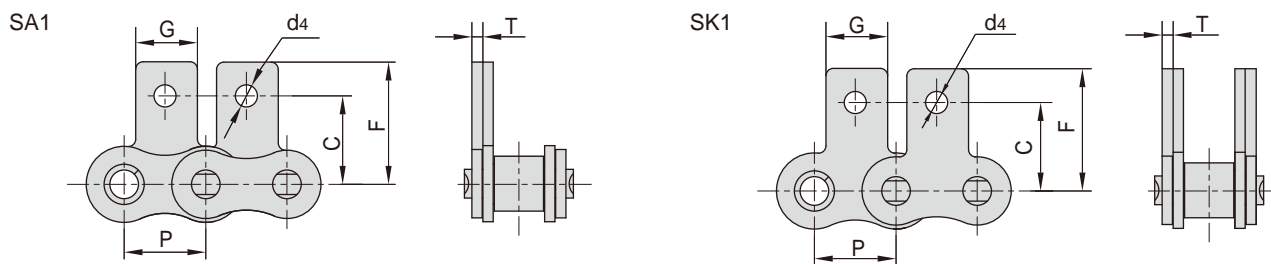

东华链号 Donghua Chain No.	P	G	C	F	T	d4
	mm	mm	mm	mm	mm	mm
08BSK1F4	12.700	11.00	13.35	18.90	1.60	6.50
08BSK1F5	12.700	9.50	13.35	18.90	1.60	6.30
08BSK1F6	12.700	11.00	14.30	19.30	1.60	4.30
08BSK1F7	12.700	11.00	13.00	20.80	1.60	4.45
41SK1F3	12.700	9.50	11.85	16.55	1.30	6.20
10ASA0F2	15.875	28.50	-	93.00	2.03	-
10ASA1F8	15.875	12.70	15.90	25.25	2.03	8.00
10ASK1F1	15.875	20.00	15.68	22.88	2.03	8.50
10ASK1F3	15.875	12.70	15.25	23.60	2.03	5.30
10ASK1F6	15.875	12.70	15.90	25.25	2.03	6.10
10BSA0F1	15.875	8.22	-	29.52	1.70	-
10BSA1F3	15.875	24.00	16.00	24.20	1.70	5.10
10BSK1F5	15.875	14.10	15.90	23.70	1.70	5.20
*C12ASK1F6	19.050	15.75	17.78	25.50	2.42	5.70
12ASA1F4	19.050	15.90	18.30	29.33	2.42	8.50
12ASK1F1	19.050	15.90	18.30	29.33	2.42	6.10
12BSA1F3	19.050	17.00	16.00	26.60	1.85	8.00
12BSA1F4	19.050	18.00	17.00	27.00	1.85	8.00
12BSK0F1	19.050	15.00	-	26.50	1.85	-
12BSK0F4	19.050	15.90	-	26.00	3.30	-
12BSK1F1	19.050	18.00	18.20	28.10	1.80	6.40
12BSK1F2	19.050	18.00	18.30	26.10	1.85	6.20
12BSK1F6	19.050	18.00	18.20	28.10	1.80	6.40
12BSK1F7	19.050	16.00	17.90	26.20	1.85	5.60
*C16ASA2F1	25.400	49.40	29.50	39.50	3.25	5.50
*C16BSK0F1	25.400	25.00	-	25.00	4.15	-

\*直链板

\*Straight side plates

## 短节距输送链附件

### Short pitch conveyor chain attachments

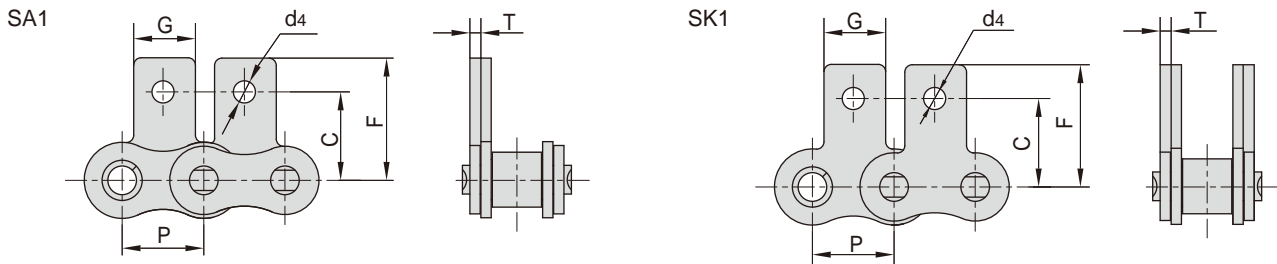

东华链号 Donghua Chain No.	P	G	C	F	T	d4
	mm	mm	mm	mm	mm	mm
*C16BSK0F3	25.400	23.94	-	22.20	3.10	-
*C16BSK0F4	25.400	46.90	-	20.50	3.10	-
16ASAF1	25.400	19.10	-	34.70	3.25	-
16ASAF2	25.400	19.10	-	34.70	3.25	-
16AWSK1F3	25.400	45.90	16.00	34.40	3.25	14.52
16BSA1F6	25.400	25.40	27.30	36.00	3.10	8.40
16BSK1F10	25.400	36.20	24.60	36.60	3.10	8.20
16BSK1F11	25.400	19.00	26.00	35.00	3.10	6.80
16BSK1F2	25.400	24.00	25.40	37.40	3.00	8.20
16BSK1F3	25.400	19.10	23.15	34.00	3.10	9.00
16BSK1F7	25.400	19.10	23.15	34.00	3.10	8.00
16BSK1F8	25.400	24.00	31.00	41.00	3.10	10.00
16BSK1F9	25.400	24.00	31.10	39.10	3.10	9.00
16BWSK0F8	25.400	47.00	-	38.00	4.15	-
20BSK1F1	31.750	25.40	30.50	45.70	3.50	9.00
24ASK1F3	38.100	28.60	34.40	50.70	4.80	9.80
24ASK1F4	38.100	28.60	36.50	51.60	4.80	10.30
24BSK1F1	38.100	30.00	42.65	61.70	4.80	10.50
24BSK1F2	38.100	36.00	43.20	61.50	4.80	20.3/11.6
24BSK1F4	38.100	30.00	36.50	51.40	4.80	10.50
28SK1F1	44.450	41.00	44.50	62.00	6.00	16.00
32ASWA2F1	50.800	92.00	48.90	69.50	6.40	13.10
32BSK1F1	50.800	50.80	53.50	77.00	6.00	14.00
40ASA1F2	63.500	63.50	40.00	56.00	8.00	22.00
40BSK1F1	63.500	56.00	48.00	68.00	8.50	16.20

\*直链板  
\*Straight side plates

## 短节距输送链附件 Short pitch conveyor chain attachments

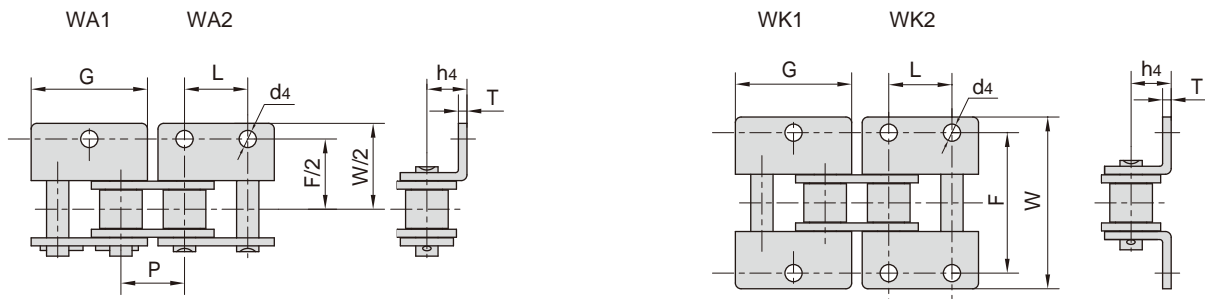

东华链号 Donghua Chain No.	P	G	L	F	W	T	h4	d4
	mm	mm	mm	mm	mm	mm	mm	mm
*06BK2F2	9.525	17.75	9.520	18.80	26.80	1.15	6.50	3.50
*06BWK2F1	9.525	17.70	9.525	19.50	28.50	1.30	6.70	4.10
06CK2F4	9.525	18.50	9.525	19.10	28.60	1.30	6.45	5.00
08AWA1F2	12.700	24.00	-	56.40	68.60	2.00	9.60	5.10
08AWA2F2	12.700	23.00	12.700	25.40	35.60	1.50	7.90	3.60
08AWK1F1	12.700	23.00	-	25.40	35.60	1.50	7.90	4.20
08AWK1F2	12.700	23.00	-	25.40	35.60	1.50	7.90	M5
08AWK1F3	12.700	23.00	-	25.52	35.72	1.50	7.90	5.50
08B(W)K2F30	12.700	23.30	12.700	28.18	37.18	1.60	8.40	4.30
08BA1F45	12.700	18.00	-	27.60	39.60	1.60	8.00	4.30
08BF30WK2	12.700	23.00	12.700	42.00	52.30	1.60	6.50	5.15
08BK2F30	12.700	23.30	12.700	28.20	37.20	1.60	8.40	4.30
08BWA1F1	12.700	23.30	-	27.40	38.80	1.60	8.00	4.30
08BWA1F16	12.700	23.10	-	26.00	36.40	1.60	8.90	6.5 × 4.5
08BWA1F17	12.700	25.00	-	30.00	45.00	1.60	10.00	8.00
08BWA1F18	12.700	23.30	-	25.50	35.20	1.60	8.90	6.00
08BWA1F19	12.700	24.00	-	25.40	36.60	1.60	7.00	M5
08BWA1F6	12.700	24.00	-	25.40	38.80	1.60	8.90	6.60
08BWA2F25	12.700	24.50	12.700	25.40	35.20	1.60	8.90	4.50
08BWA2F30	12.700	23.30	12.700	30.00	42.00	1.60	8.50	4.30
08BWA2F31	12.700	23.30	14.000	25.40	43.00	1.60	8.90	4.00
08BWA2F33	12.700	23.30	12.700	27.60	40.80	1.60	8.50	4.30
08BWA2F34	12.700	23.60	12.700	32.60	44.60	1.60	9.50	4.20
08BWA2F4	12.700	24.00	12.700	25.40	36.40	1.60	8.90	4.30
08BWA2F6	12.700	25.00	12.500	26.00	35.60	1.60	8.90	4.50
08BWK1F10	12.700	24.00	-	62.83	75.43	2.00	10.00	5.00
08BWK1F11	12.700	23.30	-	25.40	35.20	1.60	8.90	5.00
08BWK1F12	12.700	23.30	-	25.40	35.10	1.60	8.90	M5
08BWK2F2	12.700	23.20	12.700	28.40	42.60	3.00	8.50	5.40

\*直链板  
\*Straight side plates

## 短节距输送链附件 Short pitch conveyor chain attachments

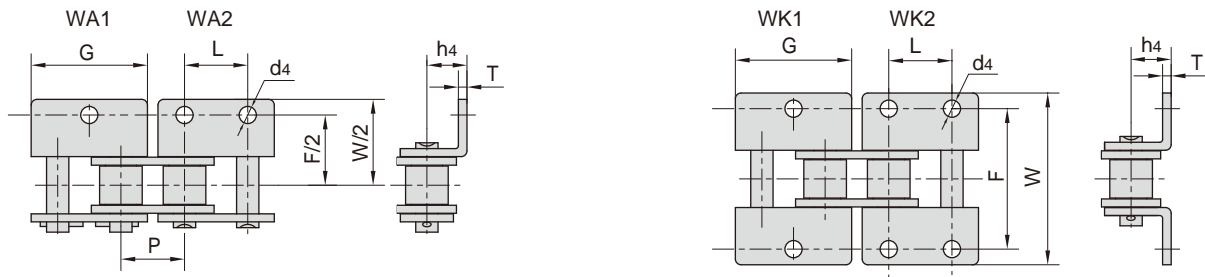

东华链号 Donghua Chain No.	P	G	L	F	W	T	h4	d4
	mm	mm	mm	mm	mm	mm	mm	mm
08BWK2F27	12.700	24.00	12.000	30.43	43.43	2.00	10.00	4.30
08BWK2F28	12.700	24.40	12.700	42.00	56.30	1.60	8.50	6.00
08BWK2F29	12.700	25.45	12.700	34.03	45.93	1.50	13.00	6.00
08BWK2F3	12.700	23.20	12.700	32.00	43.60	1.60	10.00	4.50
08BWK2F32	12.700	23.30	12.700	25.40	40.00	1.60	8.90	M5
08BWK2F39	12.700	24.50	12.700	27.60	41.80	1.60	8.50	4.80
08BWK2F4	12.700	24.00	12.700	25.40	36.40	1.60	8.90	4.30
08BWK2F40	12.700	23.10	12.700	26.00	36.40	1.60	8.90	6.50 × 4.50
08BWK2F5	12.700	24.20	12.700	23.95	34.95	1.55	8.75	4.30
40WK2F2	12.700	24.00	12.700	25.40	34.70	1.50	8.30	3.18
41WA1F4	12.700	22.30	-	30.00	41.00	1.30	7.20	5.00
428HWK1	12.700	23.30	-	38.00	56.40	2.42	11.00	5.50
10A(W)A2F1	15.875	24.10	15.875	33.60	43.20	2.03	8.20	3.50
10AWA1F2	15.875	28.80	-	32.40	42.20	2.03	10.30	5.20
10AWA1F6	15.875	28.80	-	31.80	46.60	2.03	10.30	6.50
10AWA2F1	15.875	24.10	15.880	30.70	43.89	2.03	10.10	3.90
10AWK1F1	15.875	28.80	-	31.75	46.00	2.03	10.30	8.20
10AWK1F2	15.875	30.00	-	31.75	46.00	2.03	10.30	5.20
10BWA1F1	15.875	28.50	-	52.00	73.00	1.70	10.50	10.00 × 8.00
10BWA2F2	15.875	28.36	15.760	30.40	39.80	1.60	10.50	5.20
10BWK1F4	15.875	29.58	-	31.80	44.60	1.70	10.31	7.30 × 5.50
10BWK2F10	15.875	28.60	15.900	31.80	47.60	1.70	10.30	5.20
10BWK2F2	15.875	28.36	15.760	30.40	39.80	1.60	10.50	5.20
10BWK2F3	15.875	29.90	15.880	31.59	45.59	1.60	10.50	5.30
10BWK2F4	15.875	29.58	15.880	31.71	48.41	1.70	10.31	5.30
10BWK2F8	15.875	29.58	15.875	31.80	44.60	1.70	10.31	7.30 × 5.50
10BWK2F9	15.875	29.90	15.880	48.20	62.20	1.60	10.50	5.30
*C12BWK2F12	19.050	35.00	19.050	37.20	58.00	1.85	11.00	6.60
12AF99	19.050	34.65	19.050	38.10	56.40	2.42	11.90	5.00

\*直链板  
\*Straight side plates



## 短节距输送链附件 Short pitch conveyor chain attachments

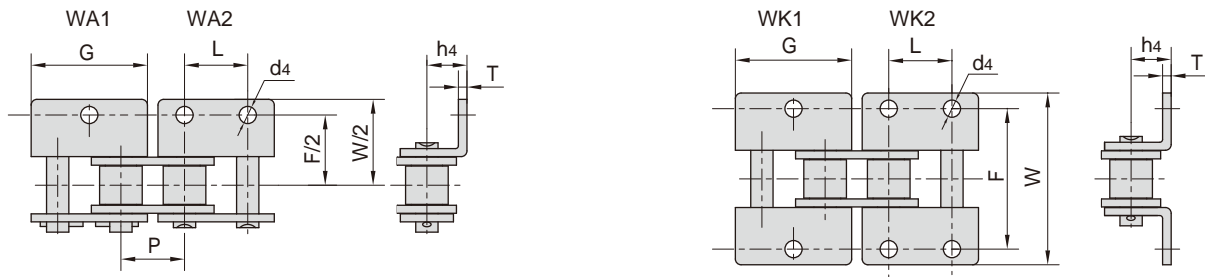

东华链号 Donghua Chain No.	P	G	L	F	W	T	h4	d4
	mm	mm	mm	mm	mm	mm	mm	mm
12AHWA2F3	19.050	34.60	19.050	38.10	56.40	3.25	13.90	6.50
12AHWK2F1	19.050	34.65	19.050	40.60	59.00	3.25	11.90	5.50
12AWA1F5	19.050	34.65	-	38.10	54.40	2.42	11.90	7.00
12AWA1F6	19.050	34.65	-	44.00	62.00	2.42	11.90	10.50
12AWA1F8	19.050	36.00	-	38.10	58.20	2.42	11.90	5.00
12AWA1F9	19.050	34.65	-	38.10	54.40	2.42	11.90	6.50
12AWA2F1	19.050	34.65	19.050	38.20	56.60	2.42	11.90	6.35
12AWA2F10	19.050	34.65	19.050	47.00	62.00	2.42	11.90	8.50
12AWA2F13	19.050	34.65	19.050	38.10	56.40	2.42	11.90	M6
12AWK1F32	19.050	34.65	-	38.10	54.40	2.42	11.90	6.00
12AWK2F5	19.050	34.65	14.300	38.10	54.40	2.42	11.90	6.00
12BF42WK2	19.050	34.90	19.000	35.20	54.60	1.85	12.20	6.40
12BWA1F13	19.050	34.65	-	35.00	51.60	1.85	13.46	7.00
12BWA1F2	19.050	34.05	-	38.10	26.20	1.85	13.46	-
12BWA2F1	19.050	34.80	19.050	35.20	61.40	1.85	12.00	5.50
12BWA2F10	19.050	34.05	19.050	38.90	56.90	1.85	13.46	7.00
12BWA2F11	19.050	32.00	19.050	38.10	56.40	1.85	11.90	5.50
12BWA2F17	19.050	37.00	19.050	38.08	52.38	1.85	13.46	6.40
12BWA2F18	19.050	34.05	19.050	38.10	52.40	1.85	18.50	6.40
12BWA2F19	19.050	37.20	19.050	35.50	56.90	1.85	12.00	6.20
12BWA2F2	19.050	34.90	19.000	35.00	50.60	1.85	12.00	6.20
12BWA2F20	19.050	35.05	19.000	35.20	50.40	1.85	12.20	6.40
12BWA2F21	19.050	34.90	19.000	35.20	54.60	1.85	12.20	6.40
12BWA2F22	19.050	34.05	19.050	37.30	56.00	1.85	11.90	6.50
12BWA2F3	19.050	30.00	20.000	37.40	53.00	1.85	12.00	6.10
12BWA2F5	19.050	30.00	20.000	39.60	55.30	1.85	14.00	M6
12BWA2F6	19.050	30.00	20.000	38.60	57.00	1.85	13.46	6.20
12BWK0F1	19.050	30.00	-	-	55.30	3.00	14.00	5.50
12BWK1F1	19.050	34.05	-	38.10	52.40	1.85	13.46	8.50

## 短节距输送链附件 Short pitch conveyor chain attachments

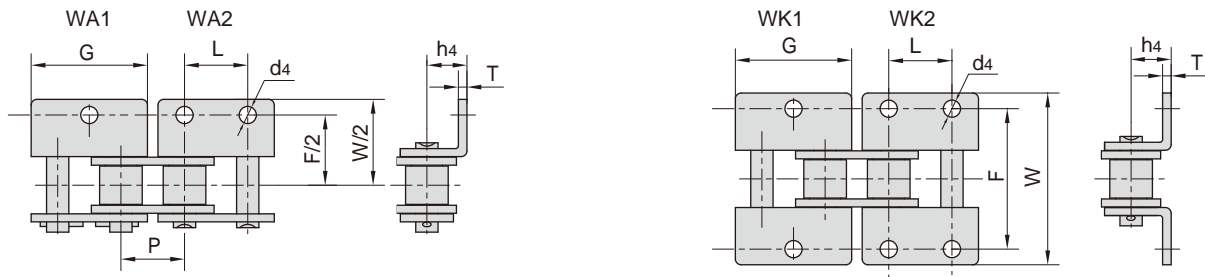

东华链号 Donghua Chain No.	P	G	L	F	W	T	h4	d4
	mm	mm	mm	mm	mm	mm	mm	mm
12BWK1F11	19.050	34.65	-	35.00	56.40	1.85	11.90	6.20
12BWK1F12	19.050	34.05	-	35.00	52.40	1.85	13.46	M6
12BWK1F14	19.050	34.05	-	36.50	52.40	1.85	11.90	10.9 × 6.4
12BWK1F15	19.050	34.85	-	34.84	51.24	1.85	11.40	6.20
12BWK2F23	19.050	34.05	19.050	36.50	52.40	1.85	11.90	10.9 × 6.4
12BWK2F25	19.050	34.05	19.050	35.10	54.60	1.85	12.00	6.60
12BWK2F27	19.050	35.25	19.050	35.40	54.90	1.80	11.60	6.40
12BWK2F28	19.050	35.00	19.000	35.00	62.80	1.85	12.00	5.60
12BWK2F7	19.050	34.90	19.000	35.00	55.40	1.85	12.20	6.40
12BWK2F8	19.050	35.60	19.050	38.10	52.40	1.85	13.50	6.60
12BWK2F9	19.050	34.90	19.000	35.00	62.40	1.85	12.20	6.20
*C16BWK2F24	25.400	46.40	25.400	50.80	72.60	3.10	15.88	8.00
16AA2F14	25.400	45.90	25.400	50.80	73.20	3.25	15.90	6.80
16AA2F18	25.400	45.90	19.050	50.80	77.50	3.25	14.125	6.70
16AA2F19	25.400	45.90	25.400	50.80	73.20	3.25	15.90	M6
16AK2F13	25.400	45.90	25.400	50.81	73.21	3.25	15.90	11.00
16AWA2F16	25.400	45.90	25.400	50.80	73.20	3.25	15.90	8.00
16AWA2F9	25.400	45.90	19.100	50.80	73.20	3.25	15.90	9.00
16AWK0F1	25.400	45.90	-	-	82.80	3.25	15.90	-
16AWK1F1	25.400	45.90	-	50.80	73.20	3.25	15.90	8.00
16AWK1F2	25.400	45.90	-	50.80	73.20	3.25	15.90	12.00
16AWK1F7	25.400	45.90	-	50.80	73.20	3.25	15.90	9.00
16AWK2F10	25.400	45.90	25.400	50.80	73.20	3.25	15.90	8.20
16AWK2F17	25.400	45.90	25.400	50.80	73.20	3.25	15.90	6.60
16AWK2F8	25.400	45.90	25.400	50.80	73.20	3.25	15.90	8.50
16BWA1F28	25.400	36.00	-	57.58	77.58	3.10	16.00	M8
16BWA2F12	25.400	46.40	25.400	50.80	77.80	3.10	15.90	8.20
16BWA2F21	25.400	45.50	25.000	54.80	83.80	3.10	16.00	M6
16BWA2F22	25.400	46.40	25.400	50.80	72.60	3.10	15.88	9.00
16BWA2F30	25.400	45.40	25.000	53.00	92.00	3.10	15.88	7.00

\*直链板  
\*Straight side plates

## 短节距输送链附件 Short pitch conveyor chain attachments

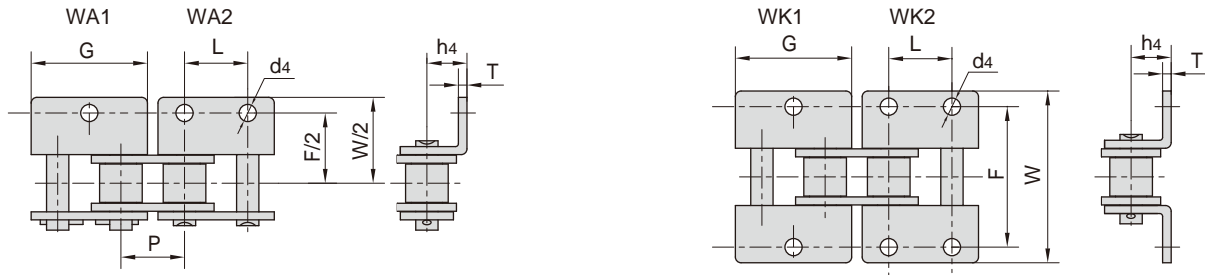

东华链号 Donghua Chain No.	P	G	L	F	W	T	h4	d4
	mm	mm	mm	mm	mm	mm	mm	mm
16BWA2F34	25.400	46.40	25.400	58.08	72.60	3.10	15.88	8.20
16BWA2F36	25.400	46.40	25.400	58.00	84.00	3.10	18.00	9.00
16BWA2F37	25.400	46.00	25.400	50.80	72.60	3.00	16.30	M8
16BWA2F7	25.400	46.40	25.400	50.80	72.00	4.15	16.00	8.00
16BWK1F	25.400	46.00	-	57.20	78.50	3.10	15.90	8.10
16BWK1F21	25.400	45.50	-	70.00	90.00	3.10	15.00	11.00
16BWK1F25	25.400	46.40	-	58.62	83.12	3.10	17.50	M6
16BWK1F26	25.400	45.50	-	70.00	90.00	3.10	15.00	11.40
16BWK1F27	25.400	46.00	-	57.20	78.50	3.10	15.90	6.50
16BWK1F3	25.400	46.40	-	50.80	72.60	3.10	15.88	M6
16BWK1F31	25.400	46.40	25.400	54.40	72.80	3.10	16.00	12.6 × 9
16BWK1F35	25.400	46.40	-	50.80	72.60	3.10	15.88	8.80
16BWK1F36	25.400	46.40	-	54.40	72.80	3.10	16.00	12.6 × 9
16BWK1F4	25.400	46.40	-	50.74	72.50	3.10	15.88	8.30
16BWK1F5	25.400	45.00	-	70.00	91.00	4.50	15.00	10.50
16BWK2F1	25.400	48.00	25.400	58.00	75.90	3.10	18.00	9.00
16BWK2F10	25.400	46.40	25.400	52.00	72.60	3.10	15.88	6.40
16BWK2F13	25.400	47.00	25.400	58.00	75.60	4.15	18.00	9.00
16BWK2F23	25.400	46.40	25.400	58.00	84.00	3.10	19.00	8.50
16BWK2F28	25.400	46.40	25.400	50.88	75.12	3.10	15.50	7.00
16BWK2F3	25.400	46.40	25.400	58.08	72.60	3.10	15.88	8.20
16BWK2F31	25.400	46.40	25.400	54.40	72.80	3.10	16.11	12.6 × 9
16BWK2F32	25.400	46.40	25.400	58.00	76.00	3.10	18.00	9.30
16BWK2F33	25.400	46.40	25.400	50.80	72.60	3.10	15.88	8.20
16BWK2F38	25.400	46.40	25.400	58.12	78.12	3.10	15.90	8.40
16BWK2F39	25.400	46.00	25.400	50.80	79.40	3.10	15.90	6.80
16BWK2F5	25.400	46.00	25.400	53.58	77.58	3.00	16.30	8.20
16BWK2F6	25.400	49.00	25.400	50.20	72.60	4.00	19.00	8.20
16BWK2F8	25.400	46.40	25.400	50.80	79.40	4.15	15.88	6.60
*C20BWK0F1	31.750	57.45	-	-	85.40	3.50	22.80	-

\*直链板  
\*Straight side plates

## 短节距输送链附件 Short pitch conveyor chain attachments

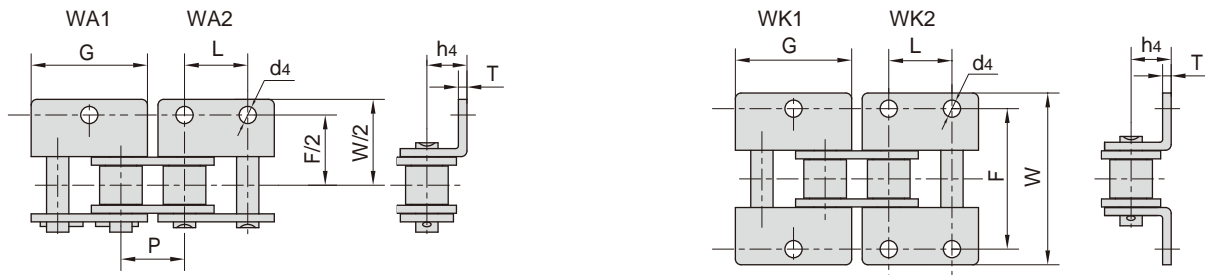

东华链号 Donghua Chain No.	P	G	L	F	W	T	h4	d4
	mm	mm	mm	mm	mm	mm	mm	mm
20AHA2F2	31.750	57.65	31.750	65.60	91.70	4.80	19.80	9.20
20AWA2F4	31.750	57.65	31.750	63.60	89.70	4.00	19.80	6.40
20BWK1F1	31.750	58.15	-	69.00	98.80	3.50	21.00	10.50
20BWK2F1	31.750	58.10	31.750	67.94	100.54	3.50	19.80	9.00
20BWK2F2	31.750	60.00	31.750	68.00	88.00	3.50	23.50	9.60
20BWK2F3	31.750	60.00	31.750	68.00	88.00	3.50	23.60	9.60
24AK2F1	38.100	69.30	38.100	76.20	109.00	4.80	23.00	10.20
24AK2F2	38.100	69.30	38.100	76.20	108.80	4.80	23.00	10.80
24AK2F4	38.100	69.30	38.100	76.20	95.00	4.80	23.00	9.80
24AK2F6	38.100	69.30	38.100	76.20	108.80	4.80	23.00	11.11
24BWK2F2	38.100	71.30	38.100	80.00	118.10	4.80	26.70	10.50
28AF16WK2	44.450	82.00	44.450	70.00	98.00	5.60	24.80	11.40
28AK2F6	44.450	80.45	42.000	69.50	107.20	5.60	28.00	10.50
28AWA2F5	44.450	80.45	44.450	88.90	123.00	5.60	28.60	20 × 12
28AWK2F1	44.450	82.00	42.000	69.50	99.00	5.60	25.10	10.50
28AWK2F4	44.450	82.00	42.000	69.50	99.00	6.00	25.10	11.20
*C32AF41K2	50.800	88.80	50.800	90.00	118.00	6.40	31.80	11.00
32AWK2F3	50.800	100.00	70.000	100.00	140.00	6.40	31.75	18.00
32AWK2F46	50.800	92.80	42.000	95.00	149.00	6.40	25.00	13.10
32AWK2F50	50.800	92.00	42.000	91.00	126.00	6.40	31.75	16.50
32BF38	50.800	60.00	-	126.00	156.00	11.00	35.00	16.00
32BK2F3	50.800	60.00	30.000	90.00	115.70	6.00	56.00	M10
32BWA2F3	50.800	92.40	50.800	105.00	147.00	6.00	31.80	12.50
32BWK2F2	50.800	92.80	40.000	76.39	111.99	6.00	31.00	12.50
32BWK2F4	50.800	92.80	42.000	94.50	150.50	6.00	25.00	13.00
32BWK2F5	50.800	92.80	50.800	101.60	142.80	6.00	31.75	13.10
40AWK2F1	63.500	115.50	63.500	127.00	179.00	8.00	42.88	16.00
40BF7	63.500	110.00	66.000	126.20	176.00	8.00	35.00	16.00
40BF8WK2	63.500	116.50	63.500	124.71	177.71	8.00	42.90	17.00

\*直链板  
\*Straight side plates

## 短节距输送链附件

### Short pitch conveyor chain attachments

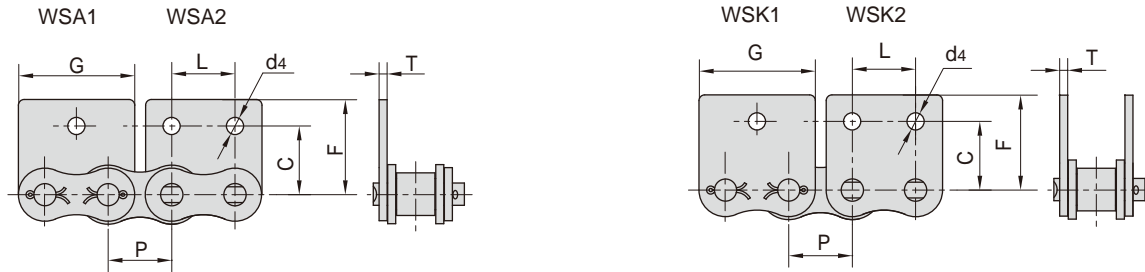

东华链号 Donghua Chain No.	P	G	L	C	F	T	d4
	mm	mm	mm	mm	mm	mm	mm
04BWSK2F1	6.000	10.50	6.000	7.00	11.00	0.60	2.20
05BWSA2F1	8.000	14.00	6.000	7.00	13.00	0.80	3.00
*06BWSA2F1	9.525	17.60	9.500	10.10	14.50	1.30	3.30
*06BWSK0F1	9.525	17.72	-	-	13.50	1.30	-
*06BWSK2F2	9.525	17.25	9.520	9.50	13.50	1.15	3.50
06CWSA2F1	9.525	17.53	9.530	8.50	14.70	1.30	4.20
06CWSA2F2	9.525	18.50	9.525	9.60	14.70	1.30	3.30
08AWSA2F1	12.700	23.00	12.700	17.47	20.65	1.50	3.60
08BWSA0F2	12.700	23.30	-	-	18.90	1.60	-
08BWSA0F4	12.700	23.20	-	-	16.00	1.60	-
08BWSA1F2	12.700	24.45	-	13.40	18.90	1.60	4.30
08BWSA2F11	12.700	23.30	12.700	13.35	18.90	1.60	4.00
08BWSA2F9	12.700	23.30	12.700	19.50	25.00	1.60	4.30
08BWSK2F1	12.700	23.30	12.700	13.35	18.90	1.60	6.10
08BWSK2F13	12.700	23.05	12.700	14.10	19.20	1.60	4.30
08BWSK2F2	12.700	24.45	12.700	13.40	18.90	1.60	4.30
08BWSK2F3	12.700	24.20	12.700	14.10	19.50	1.55	4.30
08BWSK2F4	12.700	23.30	12.700	14.10	18.50	1.60	4.30
08BWSK2F8	12.700	23.30	12.700	13.35	18.90	1.60	5.00
*C10BWSK0F1	15.875	29.58	-	-	22.95	1.70	-
10AWSA0F5	15.875	30.30	-	-	24.10	2.03	-
10AWSA0F6	15.875	28.90	-	-	19.70	2.03	-
10AWSA1F1	15.875	30.88	-	17.50	33.50	2.03	6.00
10AWSK2F1	15.875	28.45	15.900	17.30	26.90	2.03	5.00
10BSK2F5	15.875	29.90	15.880	16.32	23.32	1.60	5.30
10BWSK2F6	15.875	28.60	15.900	15.90	23.70	1.70	5.20
*C12AWSA1F1	19.050	34.05	-	17.60	25.80	2.42	9.00
*C12BWSK0F7	19.050	34.05	-	-	22.00	1.85	-
12AWSA0F1	19.050	37.05	-	-	24.00	2.42	-
12AWSA0F2	19.050	34.65	-	-	26.86	2.42	-
12AWSA2F2	19.050	34.65	19.050	17.57	26.80	2.42	5.50
12AWSK1F2	19.050	34.65	-	15.75	33.53	2.42	16.13
12AWSK2F1	19.050	34.65	19.050	18.30	26.86	2.42	9.00
12BSK1F6	19.050	18.00	-	18.20	28.10	1.80	6.40
12BSK2F1	19.050	34.05	19.050	18.20	28.60	1.85	6.40
12BWSK0F10	19.050	34.05	-	-	15.00	1.85	-
12BWSK0F8	19.050	34.05	-	-	12.00	1.85	-

\*直链板  
\*Straight side plates

## 短节距输送链附件

### Short pitch conveyor chain attachments

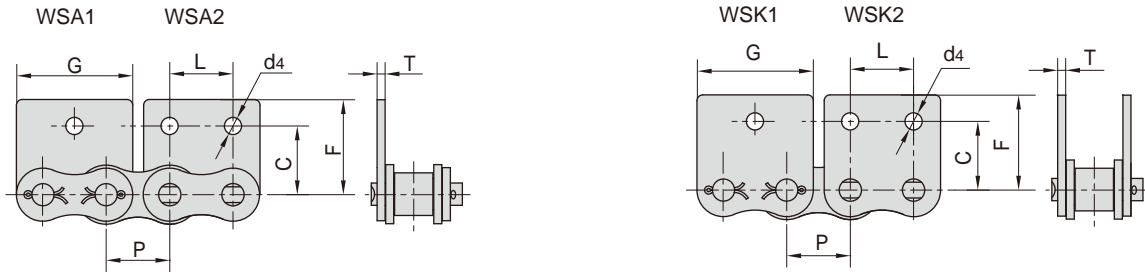

东华链号 Donghua Chain No.	P	G	L	C	F	T	d4
	mm	mm	mm	mm	mm	mm	mm
12BWSK1F1	19.050	35.20	-	20.58	30.30	1.85	6.35
12BWSK2F2	19.050	34.90	19.000	17.80	25.90	1.85	6.20
12BWSK2F3	19.050	34.90	19.000	17.80	25.90	1.85	5.50
12BWSK2F4	19.050	37.20	19.000	18.30	29.00	1.85	6.20
12BWSK2F5	19.050	34.05	19.050	19.00	30.50	1.85	5.72
12BWSK2F6	19.050	34.90	19.000	17.90	32.00	1.85	5.60
*C16BSK0F4	25.400	35.00	-	-	25.00	3.00	-
*C16BWSK0F1	25.400	46.40	-	-	24.00	3.10	-
*C16BWSK0F6	25.400	25.00	-	-	25.00	3.10	-
16AWSK1F3	25.400	45.90	-	16.00	34.40	3.25	14.52
16AWSK1F4	25.400	45.90	-	16.00	34.40	3.25	15.56
16AWSK1F5	25.400	45.90	-	16.00	34.40	3.25	17.15
16AWSK1F6	25.400	45.90	-	16.00	34.40	3.25	16.00
16AWSK2F1	25.400	45.90	19.100	24.60	35.45	3.25	9.00
16BF95	25.400	46.40	25.400	27.50	40.00	3.10	8.28
16BWSA2F6	25.400	49.00	25.400	25.50	37.60	4.00	8.20
16BWSK0F9	25.400	46.40	-	-	24.00	4.15	-
16BWSK1F8	25.400	47.00	25.400	31.10	39.70	4.15	9.00
16BWSK2F10	25.400	46.50	25.400	28.60	41.50	3.10	9.00
16BWSK2F15	25.400	46.40	25.400	23.15	34.00	3.10	6.40
16BWSK2F16	25.400	45.85	25.400	26.00	36.75	3.10	6.80
16BWSK2F5	25.400	46.00	25.400	25.40	37.50	3.00	8.20
16BWSK2F7	25.400	47.00	25.400	31.10	39.70	3.10	6.60
16BWSK2F8	25.400	46.40	-	25.00	37.00	3.10	8.20
16BWSK2F9	25.400	47.00	25.400	31.10	39.70	4.15	9.00
20AWSK1F2	31.750	57.65	-	31.80	44.00	4.00	16.00
20AWSK1F3	31.750	57.65	-	31.80	34.98	4.00	16.00
20BWSK2F2	31.750	58.10	31.750	35.00	50.00	3.50	9.00
20BWSK2F3	31.750	52.00	32.000	26.00	36.00	4.50	9.00
24AWSK2F1	38.100	69.30	38.100	34.40	50.70	4.80	9.80
24BWSK2F1	38.100	71.30	38.100	45.00	55.60	4.80	10.50
24BWSK2F3	38.100	71.30	38.100	41.00	60.00	4.80	11.00
140HWSK0F1	44.450	80.48	-	-	43.00	5.00	-
28AWSK2F2	44.450	80.45	44.450	44.20	61.25	5.60	11.40
32AF5	50.800	93.00	50.800	38.10	56.65	6.40	13.50
32AWSK2F1	50.800	92.00	50.800	100.00	150.00	6.40	13.10
40AWSK2F1	63.500	115.60	63.500	63.50	89.00	8.00	17.00

\*直链板  
\*Straight side plates

## 短节距输送链附件

### Short pitch conveyor chain attachments

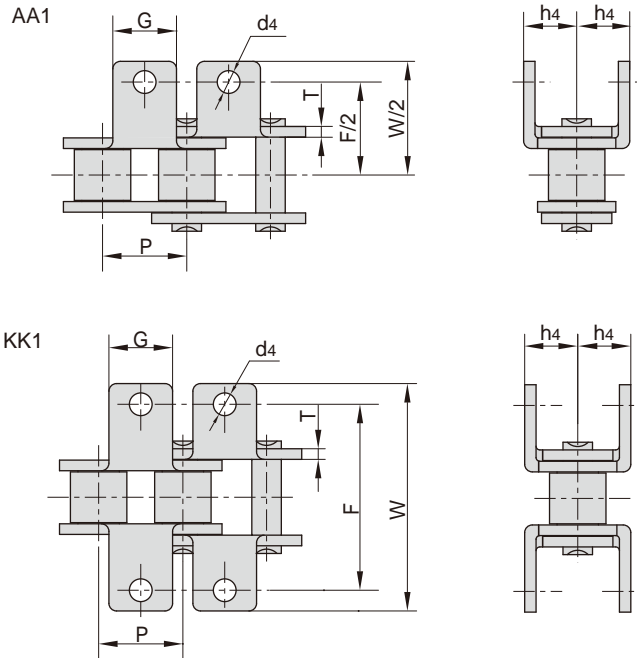

ISO 链号 ISO Chain No.	东华链号 Donghua Chain No.	P	G	F	W	T	h4	d4
		mm	mm	mm	mm	mm	mm	mm
40	08A	12.700	9.5	25.40	35.2	1.50	7.90	3.4
50	10A	15.875	12.7	31.75	46.2	2.03	10.30	5.5
60	12A	19.050	15.9	38.10	55.6	2.42	11.90	5.5
80	16A	25.400	19.1	50.80	64.8	3.25	15.90	6.8
100	20A	31.750	25.4	63.50	87.3	4.00	19.80	9.2
120	24A	38.100	28.6	76.20	108.5	4.80	23.00	9.8
*06B	*06B	9.525	8.0	19.04	27.0	1.30	6.50	3.5
08B	08B	12.700	9.5	25.40	36.4	1.60	8.90	4.5
10B	10B	15.875	14.3	31.75	44.6	1.70	10.31	5.3
12B	12B	19.050	16.0	38.10	52.4	1.85	13.46	6.4
16B	16B	25.400	19.1	50.80	72.6	3.10	15.88	6.4
20B	20B	31.750	35.0	63.50	100.5	3.50	19.80	9.0
24B	24B	38.100	30.0	76.20	108.4	4.80	26.67	10.5
	08AA1F9	12.700	9.6	55.40	62.5	2.03	7.50	4.2
	08AA1F10	12.700	9.6	28.00	36.4	1.50	8.50	3.2
	08AA1F11	12.700	9.5	25.40	35.2	1.50	7.90	5.5
	08AA1F12	12.700	9.5	25.40	35.2	1.50	7.90	3.2
	08AKK1F1	12.700	9.5	25.40	36.4	1.50	8.90	4.5
	80HAA1F1	25.400	20.0	62.00	79.6	3.24	35.60	8.1
	24BAA1F2	38.100	35.0	83.80	103.8	6.00	36.15	10.0
	28BKK1F2	44.450	35.0	117.00	147.0	6.00	22.50	12.0

\*直链板  
\*Straight side plates